

LUMIÈRE LIGHTING  
TECHNOLOGY

# PRODUCT CATALOGUE

# OUR VALUES

HERITAGE **RELIABILITY**  
QUALITY **DURABILITY**  
DURABILITY **HEALTH**

Exceptional performance, attention to details, originality and sustainability are the driving forces behind Lumière lighting solutions. Those are solutions and characteristics that ensure the company to be the credible and trustworthy member of the market, capable of making genuine contributions to improving the environment in which we live.

**LITY DURABILIT**  
**BILITY HE**  
**ERITAGE RELIAB**

## OUR PHILO

At Lumière, we believe  
simply about visibility,  
creating emotion,  
atmosphere.  
Every space deserve  
complements its  
enhances its purpos  
visual comfort with  
precision.

## OUR LEADERSHIP

Lumière Lighting Technology is led by  
professionals with extensive  
experience in lighting solutions,  
project coordination, technical  
support, and business development  
within the lighting industry.

# SOPHY

Lighting is not  
just about  
identity, and

is lighting that  
architecture,  
and delivers  
elegance and

## OUR APPROACH

To illuminate every space with innovative, sustainable lighting solutions that enhance comfort, productivity, and aesthetic appeal for homes and businesses alike.

## INDOOR LIGHTING RECESSED - SURFACE LUMINAIRES

BACKLIT REC



BACKLIT SUR



COVER IP40/44



COVER IP65



VANDAL- CP6

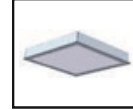

LOUVER - IP20



INDIRECT



## INDOOR LIGHTING RECESSED DOWN LIGHT

DLR26 IP40/IP44



DLR37 IP54/65



DLR66 IP40/44



DLR46 IP54



DLR61 IP65



DLR24 IP20



DLR8 IP65



DLR42 IP44



DLR60 IP54



DLR48 IP20



DLR50 IP65



DLR51 IP44&IP65



DLS8 IP65



DLR10 IP66



DLR57 IP65



## INDOOR LIGHTING SPOT LIGHT AND TRACK

SP16 IP40



SP58 IP65



SP19 IP40



SP21 IP20



SP27 IP20



SP32 IP20/44



SP28 IP44



SP29 IP44



GL2 - 2X2WIP20



TR02 IP20



TR01 IP20



TR06 IP44



TR05 IP20



## INDOOR LIGHTING SURFACE DOWN LIGHT

CM04 IP54



D49 IP20



D44XIP40



D12XIP20 / IP44



D40X IP44



D56X IP20



## INDOOR LIGHTING INDUSTRIAL LIGHTING

WAT IP65



WAT01 IP66



## INDOOR LIGHTING WRAPARROUND LIGHT

FULLY WRR IP40



## INDOOR LIGHTING MIRROR LIGHT

MIRROR IP44



## INDOOR LIGHTING PROLINE LIGHT

Circular Ring IP20

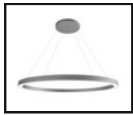

LINEAR RD 95

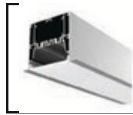

LINEAR CD 90



## INDOOR LIGHTING EMERGENCY LIGHT

EXIT IP20



EXIT TWIN IP65



EXIT TWIN IP65



EXIT PC



## OUTDOOR LIGHTING ROAD LIGHTING

VEGA IP66



MOON IP66



MODULE IP67



## OUTDOOR LIGHTING TUNNEL LIGHTING

TL01 IP66



## OUTDOOR LIGHTING AREA - FLOOD LIGHT

DIAMOND II IP66



FOOLD ECO IP66



FLD05 IP66



FLD07 IP66



FLD09 IP66



PROJECTOR IP66



## OUTDOOR LIGHTING SPORT LIGHT

FLD06X IP66



FLD08X IP66



FLD11X IP66



FLD13X IP65



## OUTDOOR LIGHTING HIGH BAY

HIGH BAY IP65



HIGH BAY ECO IP65



## OUTDOOR LIGHTING WALL LIGHT

WL08 IP66



WUDL07 IP66



WDL05 IP65



WL9 IP54



WL01 IP65



WUDL06 IP66



WUDL05 IP65



## OUTDOOR LIGHTING POST TOP

GL - 10 IP65



GL - 11 IP65



GL - 12 IP65



GL - 13 IP65



## OUTDOOR LIGHTING BOLLARD

BOLLARD 04 IP66



BOLLARD 03 IP66



BOLLARD 02 IP65



## OUTDOOR LIGHTING SPIKE

SPIKE 04 IP66



SPIKE 03 IP66



## OUTDOOR LIGHTING UP LIGHT

UPL - 14 IP67



UPL-22 IP67



UPL - 11 IP67



UPL - 23 IP67



UPL - 25 IP67



## OUTDOOR LIGHTING WALL WASHER

WW06 IP67



WW07 IP67



## OUTDOOR LIGHTING STEP LIGHT

SP01XSERIESIP65



WL07XIP65



STEP01X IP67

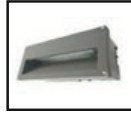

## OUTDOOR LIGHTING GAS STATION

LOWBAY01XIP65



## OUTDOOR LIGHTING POOL LIGHT

PL01X IP68



## STREET LIGHTING SOLAR SYSTEM

EO - SSTSeries



STQ Series IP65



NSB - 01XIP65



NSB - 02XIP65



NSB - 03XIP6



NSB - 06XIP67



INDOOR

# RECESSED - SURFACE LUMINAIR

**APPLICATIONS:**

Office, training room, conference room  
and classroom, etc.

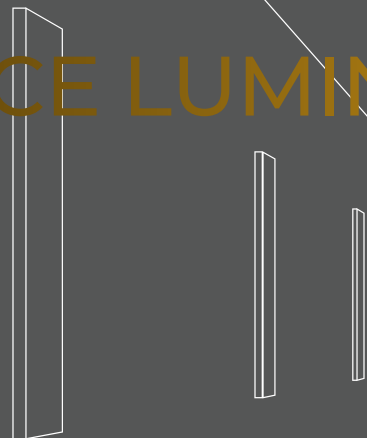







# Backlit Recessed

## APPLICATIONS:

Suitable to be used in : Universities, hotels, office lighting, restaurants school & hospital

## التطبيقات

مناسبة للاستخدام في : الجامعات، الفنادق، إضاءة المكاتب، المطاعم، المدارس والمستشفيات.





## General Specifications:

 Mounted	Ceiling recessed
 Material	Prepainted Pressed Steel
 IP	IP40/54
 50,000 Hrs (L70 @ 25C°)	
 -10 : 40°C	
 warranty	5 Years

## Optical Data:

 chips	High Quality LED Chip
 COB SMD	SMD
 Lm	100 lm/W
 beam angle	120°
 CCT	3000K/4000K/6000K
 CRI	> 80

## Electrical Data:

 LED Wattage	24W/40W/48W/72W
 driver	Electronic LED driver
 Voltage	(220-240) Vac
 HZ	50-60 Hz
 PF	> 0.95

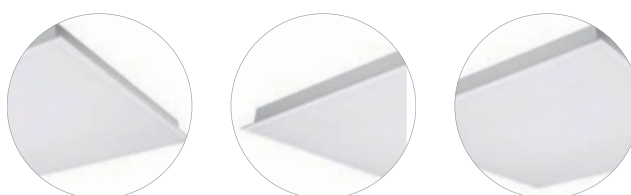

## DESCRIPTIONS:

Backlit IP40/IP54 is the new technology to replace conventional T5 and T8 general lighting luminaries With high system lumen output 100 lm/W, based on the most advanced LED chips and drivers, Lumière released the products that can replace all fluorescent configurations which extends product life time with best power consumption and Performance

## الوصف

Backlit IP40/IP54 هي التكنولوجيا الجديدة لاستبدال مصابيح الإضاءة العامة التقليدية T5 و T8. مع خرج لومن عالي للنظام يبلغ 100 لومن/واط، تعتمد على أحدث رقائق LED والمحركات.

## SPECIFICATIONS:

Model	Wattage	Lumen	Driver Type	L	W	H
Backlit 24W	24W	2400 Lm	Constant Current LED Driver	295mm	595mm	33mm
Backlit 40W	40W	4000 Lm	Constant Current LED Driver	595mm	595mm	33mm
Backlit 40WL	40W	4000 Lm	Constant Current LED Driver	295mm	1195mm	33mm
Backlit 48W	48W	4800 Lm	Constant Current LED Driver	595mm	595mm	33mm
Backlit 48WL	48W	4800 Lm	Constant Current LED Driver	295mm	1195mm	33mm
Backlit 72WL	72W	7200 Lm	Constant Current LED Driver	595mm	1195mm	33mm

## ILLUSTRATION

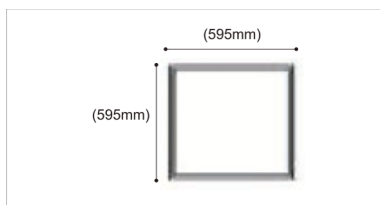

## LIGHT DISTRIBUTION

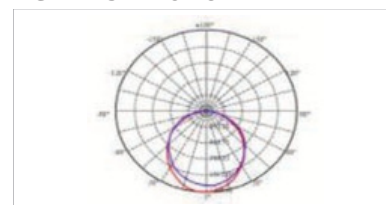

## OPTIONS:

-  Dimmable Driver 1-10 / DALI



Backup Emergency Kit 1H/3H





# BACKLIT Surface

## APPLICATIONS:

Suitable to be used in : Hotels, office lighting, restaurants school & hospital.

## التطبيقات

مناسبة للاستخدام في : الجامعات، الفنادق، إضاءة المكاتب، المطاعم، المدارس والمستشفيات.





## General Specifications:

 Mounted	Ceiling recessed
 Material	Prepainted Pressed Steel
 IP	IP40/54
 50,000 Hrs ( L70 @ 25C° )	
 -10 : 40°C	
 warranty	5 Years

## Optical Data:

 chips	High Quality LED Chip
 COB SMD	SMD
 Lm	100 lm/W
 beam angle	120°
 CCT	3000K/4000K/6000K
 CRI	> 80

## Electrical Data:

 LED Wattage	24W/40W/48W/72W
 driver	Electronic LED driver
 Voltage	(220-240) Vac
 HZ	50-60 Hz
 PF	> 0.95



## DESCRIPTIONS:

Backlit IP40/IP54 is the new technology to replace conventional T5 and T8 general lighting luminaries With high system lumen output 100 lm/W, based on the most advanced LED chips and drivers, Lumière released the products that can replace all fluorescent configurations which extends product life time with best power consumption and Performance.

## الوصف

Backlit IP40/IP54 هي التكنولوجيا الجديدة لاستبدال مصابيح الإضاءة العامة التقليدية T5 و T8. مع خرج لومن عالي للنظام يبلغ 100 لومن/واط، تعتمد على أحدث رقائق LED والمحركات.

## SPECIFICATIONS:

Model	Wattage	Lumen	Driver Type	L	W	H
Backlit SUR 24W	24W	2400 Lm	Constant Current LED Driver	300mm	600mm	40mm
Backlit SUR 40W	40W	4000 Lm	Constant Current LED Driver	600mm	600mm	40mm
Backlit SUR 40WL	40W	4000 Lm	Constant Current LED Driver	300mm	1200mm	40mm
Backlit SUR48W	48W	4800 Lm	Constant Current LED Driver	600mm	600mm	40mm
Backlit SUR 48WL	48W	4800 Lm	Constant Current LED Driver	300mm	1200mm	40mm
Backlit SUR 72WL	72W	7200 Lm	Constant Current LED Driver	600mm	1200mm	40mm

## ILLUSTRATION

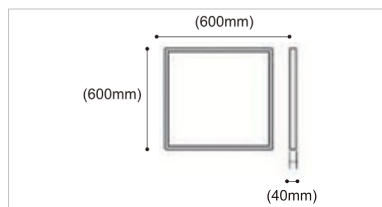

## LIGHT DISTRIBUTION

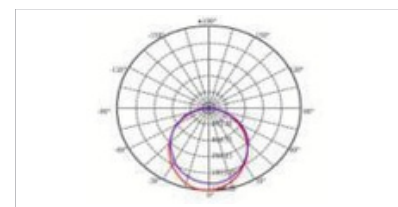

## OPTIONS:

-  Dimmable Driver 1-10 / DALI



Backup Emergency Kit 1H/3H

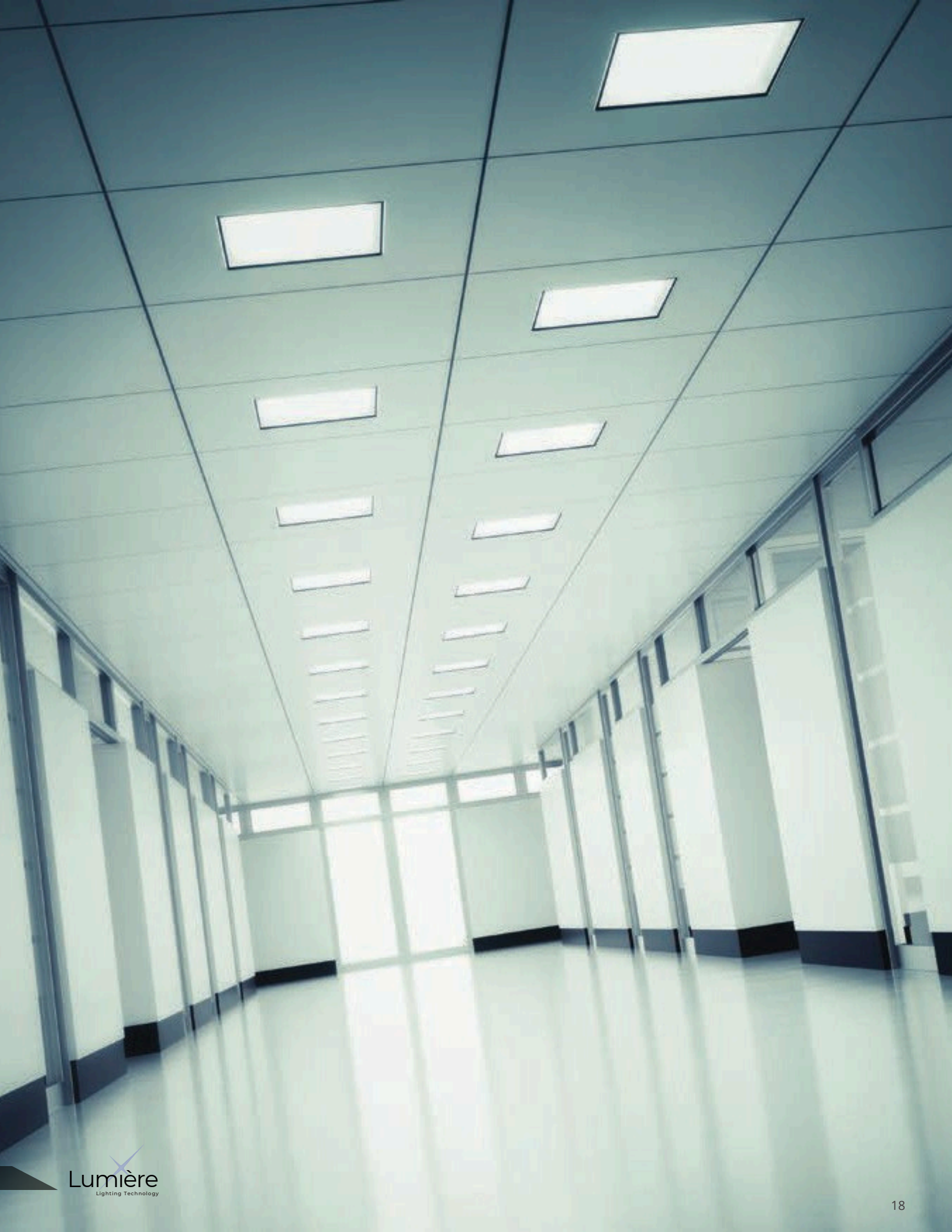



# COVER IP40/44

## APPLICATIONS:

Suitable to be used in : hospitals, laboratories, pharmaceutical production and food production.

## التطبيقات

مناسبة للاستخدام في : المستشفيات والمختبرات وصالات إنتاج الأدوية وإنتاج الغذاء.





## General Specifications:

 Mounted	Ceiling recessed
 Material	Cold Rolled Galvanized Steel
 IP	IP40/44
 50,000 Hrs ( L70 @ 25C° )	
 -10 : 40°C	
 warranty	5 Years

## Optical Data:

 chips	High Quality LED Chip
 COB SMD	SMD
 Lm	100 lm/W
 beam angle	120°
 CCT	3000K/4000K/6500K
 CRI	> 80

## Electrical Data:

 LED Wattage	24W/36W/48W/72W
 driver	Constant current LED driver
 Voltage	(220-240) Vac
 HZ	50-60 Hz
 PF	> 0.95



## DESCRIPTIONS:

Cover LED IP40/44 is the new technology to replace conventional T5 and T8 general lighting luminaries With high system lumen output 100 lm/W, based on the most advanced LED chips and drivers, Lumière released the products that can replace all fluorescent configurations which extends product life time with best power consumption and Performance. lighting fixtures which are easy to clean, water proof and dust proof should be used.

## الوصف

COVER IP40/IP44 هي التكنولوجيا الجديدة لاستبدال مصابيح الإضاءة العامة التقليدية T5 و T8. مع خرج لومن عالي للنظام يبلغ 100 لومن/واط، تعتمد على أحدث رقائق LED والمحركات.

## SPECIFICATIONS:

Model	Wattage	Lumen	Driver Type	L1	L2	H
CoverLED IP40/44 - 24W	24W	1800 Lm	Constant Current LED Driver	295mm	295mm	60mm
CoverLED IP40/44 - 36W	36W	2700 Lm	Constant Current LED Driver	595mm	595mm	60mm
CoverLED IP40/44 - 48W	48W	3600 Lm	Constant Current LED Driver	595mm	595mm	60mm
CoverLED IP40/44 - 48WL	48W	3600 Lm	Constant Current LED Driver	295mm	1195mm	60mm
CoverLED IP40/44 - 72WL	72W	4500 Lm	Constant Current LED Driver	595mm	1195mm	60mm

## ILLUSTRATION

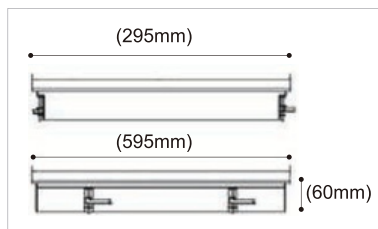

## LIGHT DISTRIBUTION

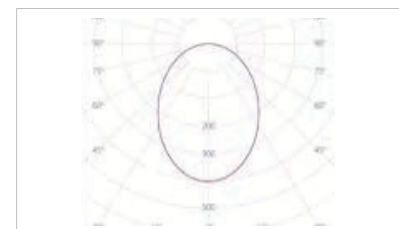

## OPTIONS:

-  Dimmable Driver 1-10 / DALI

 Backup Emergency Kit 1H/3H



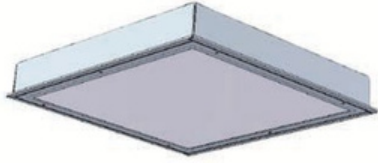

# VANDAL - CP6

## APPLICATIONS:

Suitable to be used in : hospitals, laboratories, pharmaceutical production and

## التطبيقات

مناسبة للاستخدام في : المستشفيات، المختبرات، إنتاج الأدوية وإنتاج الأغذية.

## General Specifications:

	Ceiling Recessed
	Cold Rolled Galvanized Steel
	IP54/55
	50,000 Hrs ( L70 @ 25C° )
	-10 : 40°C
	5 Years

## Optical Data:

	High Quality LED Chip
	SMD
	100 lm/W
	120°
	3000K/4000K/6500K
	> 80

## Electrical Data:

	24W/40W/48W/72W
	Constant current LED driver
	(220-240) Vac
	50-60 Hz
	> 0.95

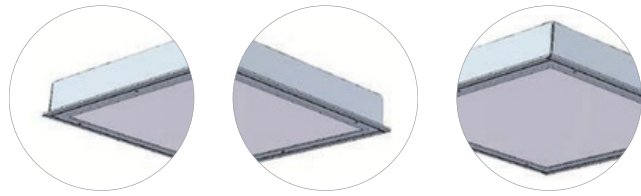

## DESCRIPTIONS:

VANDAL CP6-IP54/55 is the new technology to replace conventional T5 and T8 general lighting luminaries With high system lumen output 80 lm/W, based on the most advanced LED chips and drivers, Lumière released the products that can replace all fluorescent configurations which extends product life time with best power consumption and Performance. lighting fixtures which are easy to clean, water proof and dust proof should be used

## الوصف

إن VANDAL-CP6-IP55 هي تقنية جديدة لتحل محل مصابيح الإضاءة العامة T5 و T8 التقليدية بكمية أضواء كلية تصل إلى 100 لومين/وات وذلك باستخدام ليدات و وحدات تحكم عالية الجودة ، وهي من المنتجات التي أصدرتها لوميير لتحل محل جميع وحدات الفلوريسنت مع إطالة العمر الافتراضي المقتن واستهلاك أفضل للطاقة ورفع مستوى الأداء. سهولة التركيب و التنظيف ومقاومة للماء والغبار.

## SPECIFICATIONS:

Model	Wattage	Lumen	Driver Type	L	W	H
REC-VAN-LED-24W/CP6 [IP54/55] [VP]	24W	1920 Lm	Constant Current LED Driver	297mm	597mm	100mm
REC-VAN-LED-48W/CP6 [IP54/55] [VP]	48W	3840 Lm	Constant Current LED Driver	597mm	597mm	100mm
REC-VAN-LED-48W/CP6 [IP54/55] [VP]	48W	3840 Lm	Constant Current LED Driver	297mm	1197mm	100mm
REC-VAN-LED-72W/CP6 [IP54/55] [VP]	72W	5760 Lm	Constant Current LED Driver	597mm	1197mm	100mm

## ILLUSTRATION

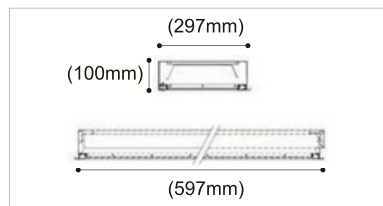

## LIGHT DISTRIBUTION

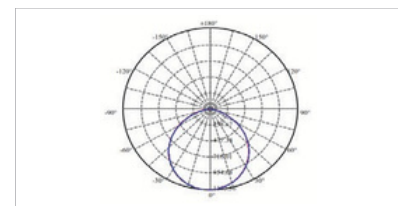

## OPTIONS:

- Dimmable Driver 1-10 / DALI

Backup Emergency Kit 1H/3H





# LED - INDIRECT - IP40





## APPLICATIONS:

Suitable to be used in : Office, Residential, commercial and other similar application

## التطبيقات

مناسبة للاستخدام في : الجامعات، الفنادق، إضاءة المكاتب، المطاعم، المدارس والمستشفيات.





## General Specifications:

 Mounted	Ceiling recessed
 Material	Coled rolled + perforated diff.
 IP	IP40/44
 50,000 Hrs ( L70 @ 25C° )	
 -10 : 40°C	
 warranty	5 Years

## Optical Data:

 chips	High Quality LED Chip
 COB SMD	SMD
 Lm	100 lm/W
 beam angle	120°
 CCT	3000K/4000K/6500K
 CRI	> 80

## Electrical Data:

 LED Wattage	36W/48W
 driver	Electronic LED driver
 Voltage	(220-240) Vac
 HZ	50-60 Hz
 PF	> 0.95



## DESCRIPTIONS:

INDIRECT LED is an indirect recessed luminaire made of high quality steel housing finished with 3-stages pretreatment electrostatic powder coating. This luminaire is used for creating task / ambient lighting effect. Energy efficiency is obtained using an integrated electronic LED driver with PF higher than 0.95.

## الوصف

IND LED هو مصباح غائر غير مباشر مصنوع من هيكل فولاذي عالي الجودة مطلي بطلاء مسحوق إلكتروستاتيكي ثلاثي المراحل. يُستخدم هذا المصباح لإنشاء تأثير إضاءة وظيفية/بيئية. يتم تحقيق الكفاءة في استهلاك الطاقة باستخدام محرك إلكتروني مدمج مع معامل قدرة أعلى من 0.95.

## SPECIFICATIONS:

Model	Wattage	Lumen	Driver Type	L	W	H
IND LED-36W	36W	3600 Lm	Remote electronic LED driver	595mm	595mm	70mm
IND LED-48W	48W	4800 Lm	Remote electronic LED driver	595mm	595mm	70mm

## ILLUSTRATION

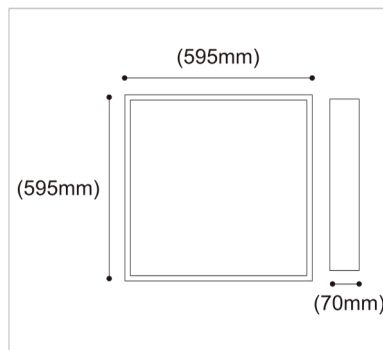

## LIGHT DISTRIBUTION

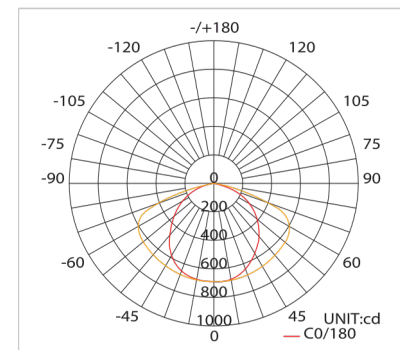

## OPTIONS:

-  Dimmable Driver 1-10 / DALI

 Backup Emergency Kit 1H/3H



INDOOR

# RECESSED - DOWN LIGHT

**APPLICATIONS:**

Office, training room, conference room  
and classroom, etc.

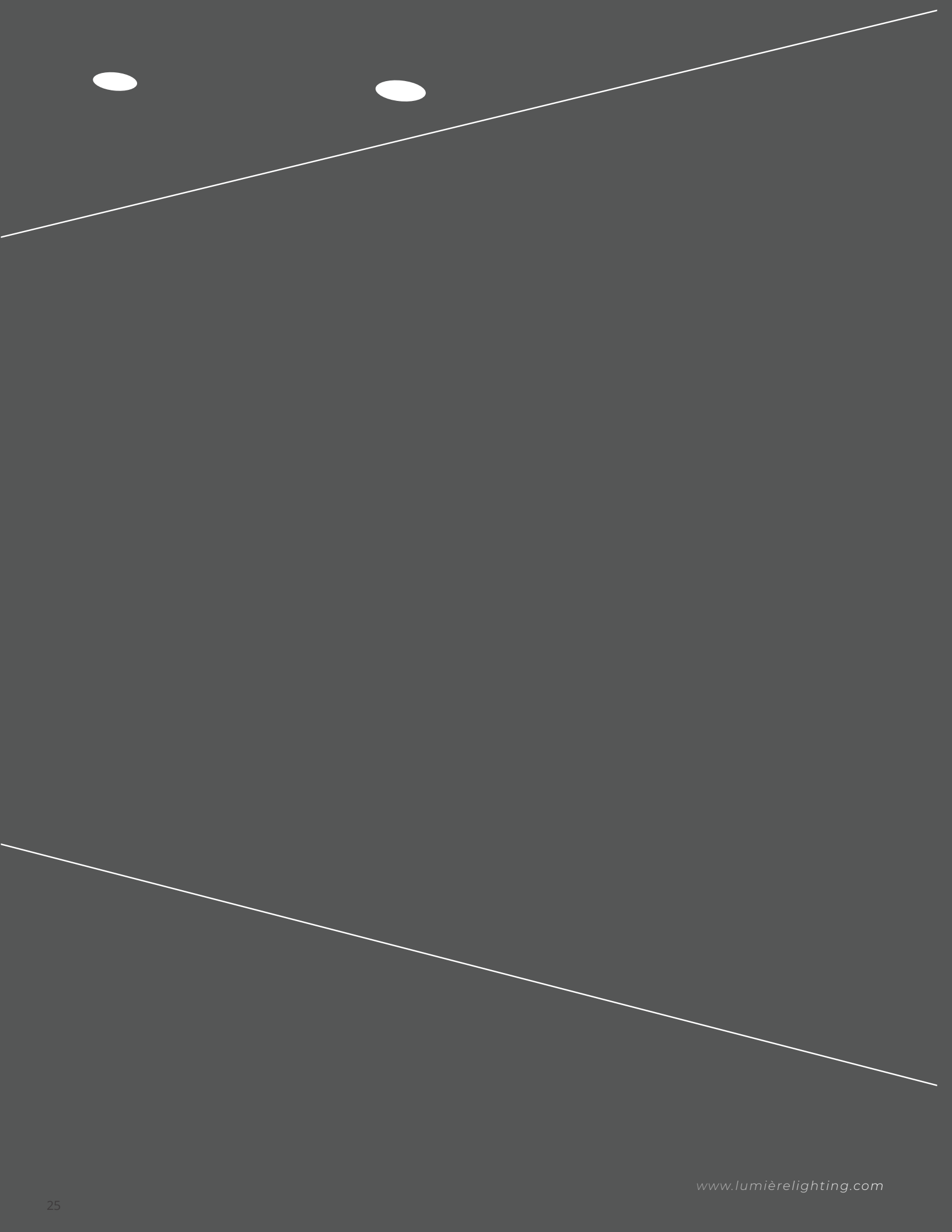





# DLR26 IP40/IP44

## APPLICATIONS:

Suitable to be used in : offices, lobbies, entrances, showrooms corridors, circulation areas, stairs, waiting area in: clinics banks, governmental premises, general lighting applications

التطبيقات مناسبة للاستخدام في : مناسبة للإستخدام في : المكاتب، المداخل، المعارض، الأسواق التجارية الممرات، السلالم، غرف الإنتظار في العيادات، البنوك، الدوائر الحكومية وجميع تطبيقات الإضاءة العامة

## General Specifications:

	Ceiling recessed
	Die casted aluminium
	IP40/IP44
	50,000 Hrs ( L70 @ 50C° )
	-10 : 40°C
	5 Years

## Optical Data:

	High Quality LED Chip
	COB
	90 lm/W
	40°-60°
	3000K/4000K/6000K
	> 80

## Electrical Data:

	7W/10W/15W/25W/30W
	Remote electronic LED driver
	(220-240) Vac
	50-60 Hz
	> 0.95

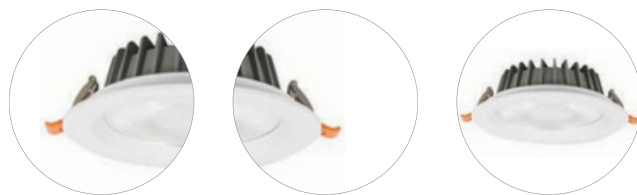

## DESCRIPTIONS:

DLR26 is a Recessed LED downlight with special super thin body design and has long Life time more than 50,000 hrs with best power consumption and Performance with high quality die-cast aluminum body. Unit provided with deep pure aluminum reflector with beam angle (40°-60°) & anti-glare, clear glass diffuser to provide high Light efficiency.

## الوصف

إن DLR26 عبارة عن سلسلة إضاءة غاطسة ليد سقفية لأسفل ذات تصميم أنيق ورائع . تعمل بإستخدام تقنية LED والتي لها عمر إفتراضي طويل يصل لأكثر من ٥٠,٠٠٠ ساعة تشغيل مما يقلل التكاليف والصيانة إلى حد كبير. الوحدة مصممة بشكل خاص لتقديم حلول الإنارة العامة للمنازل والمكاتب والمعارض والفنادق وكافة التطبيقات المشابهة . الوحدة مزودة بمحول تشغيل إلكتروني ذو جودة عالية حسب المواصفات القياسية السعودية والدولية و ذات هيكل من الألمنيوم المسبوك المطلي بدهان إلكتروستاتيكي عالي الجودة . الوحدة مزودة بعاكس عميق من الألمنيوم النقي بزوايا إضاءة ( 40° - 60 ° ) و مضاد للوهج مع ناشر من الزجاج الشفاف لضمان مردوداً ضوئياً عالياً .

## SPECIFICATIONS:

Model	Wattage	Lumen	Driver Type	D	H	Cut-Out Hole Size
LED-D261-7W	7W	840 Lm	Constant Current LED Driver	90mm	45mm	75mm
LED-D262-10W	10W	1200 Lm	Constant Current LED Driver	135mm	50mm	115mm
LED-D263-15W	15W	1800 Lm	Constant Current LED Driver	165mm	55mm	145mm
LED-D264-25W-30W	25-30W	2600-3000 Lm	Constant Current LED Driver	220mm	65mm	195mm

## ILLUSTRATION

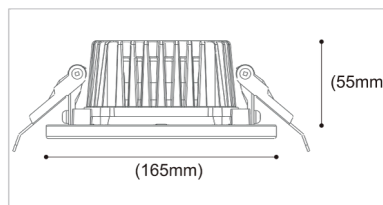

## LIGHT DISTRIBUTION

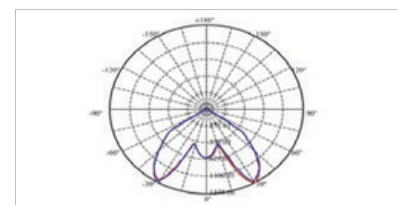

## OPTIONS:

- Dimmable Driver 1-10 / DALI Backup Emergency Kit 3Hr





# DLR37 IP54/65

## APPLICATIONS:

Suitable to be used in : hotels, reception room, restaurants, exhibitions, showrooms and commercial spaces.

## التطبيقات

مناسبة للإستخدام في : الفنادق، غرفة الاستقبال، المطاعم، المعارض، صالات العرض، والمساحات التجارية.





## General Specifications:

 Mounted	Ceiling recessed
 Material	Die casted aluminium
 IP	IP54/65
 Life time	50,000 Hrs ( L70 @ 50C° )
 Temperature	-10 : 40°C
 Warranty	5 Years

## Optical Data:

 chips	High Quality LED Chip
 COB SMD	COB
 Lm	120 lm/W
 beam angle	40°-60°
 CCT	3000K/4000K/65 00K
 CRI	> 80

## Electrical Data:

 LED Wattage	7W/10W/15W/25W/30W
 driver	Electronic LED driver
 Voltage	(220-240) Vac
 HZ	50-60 Hz
 PF	> 0.95



## DESCRIPTIONS:

DLR37 is a Recessed LED downlight with special super thin body design IP65 and has long Life time more than 50,000 hrs with best power consumption and Performance with high quality die-cast aluminum body. Unit provided with deep pure aluminum reflector with beam angle (40°-60°) & anti-glare, clear glass diffuser to provide high Light efficiency.

## الوصف

إن DLR26 عبارة عن سلسلة إضاءة غاطسة ليد سقفية لأسفل ذات درجة حماية عالية IP65 ، تعمل باستخدام تقنية LED والتي لها عمر إفتراضي طويل يصل لأكثر من ٥٠,٠٠٠ ساعة تشغيل مما يقلل التكاليف والصيانة إلى حد كبير . الوحدة مزودة بمحول تشغيل إلكتروني ذو جودة عالية حسب المواصفات القياسية السعودية والدولية و ذات هيكل من الألومنيوم المسبوك المطلي بدهان إلكتروستاتيكي عالي الجودة. الوحدة مزودة بعاكس عميق من الألومنيوم بالنقى بزواوية إضاءة ( 40° - 60 ° ) و مضاد للوهج مع ناشر من الزجاج الشفاف لضمان مردودا صوتيا عاليا .

## SPECIFICATIONS:

Model	Wattage	Lumen	Driver Type	D	H	Cut-Out Hole Size
LED-D261-7W	7W	840 Lm	Constant Current LED Driver	90mm	45mm	75mm
LED-D262-10W	10W	1200 Lm	Constant Current LED Driver	135mm	50mm	115mm
LED-D263-15W	15W	1800 Lm	Constant Current LED Driver	165mm	55mm	145mm
LED-D264-25W-30W	25-30W	2600-3000 Lm	Constant Current LED Driver	220mm	65mm	195mm

## ILLUSTRATION

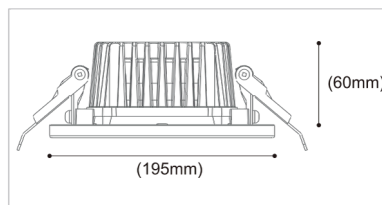

## LIGHT DISTRIBUTION

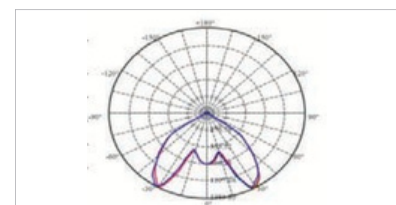

## OPTIONS:

-  Dimmable Driver 1 -10 / DALI
-  Backup Emergency Kit 3Hr





# DLR66 IP40/44

## APPLICATIONS:

Suitable to be used in : offices, lobbies, entrances, showrooms corridors, circulation areas, stairs, waiting area in: clinics banks, governmental premises, general lighting applications

التطبيقات المناسبة للاستخدام في : مناسبة للإستخدام في : المكاتب، المداخل، المعارض، الأسواق التجارية، الممرات، السلالم، غرف الإنتظار في العيادات، البنوك، الدوائر الحكومية وجميع تطبيقات الإضاءة العامة





## General Specifications:

 Mounted	Ceiling recessed
 Material	Die casted aluminium
 IP	IP40
 50,000 Hrs ( L70 @ 50C° )	
 -20 : 45°C	
 warranty	5 Years

## Optical Data:

 chips	High Quality LED Chip
 COB SMD	SMD
 Lm	90 lm/W
 beam angle	120°
 CCT	3000K/4000K/6500K
 CRI	> 80

## Electrical Data:

 LED Wattage	7W/10W/15W/25W/30W
 driver	Integrated LED constant cur.
 Voltage	(220-240) Vac
 HZ	50-60 Hz
 PF	> 0.95



## DESCRIPTIONS:

DLR66 is a Recessed LED downlight with special super thin body design and has long Life time more than 50,000 hrs with best power consumption and Performance .It's equipped with high efficient electronic driver as per Saudi and international Standards with high quality die-cast aluminum body. Unit provided with deep pure aluminum reflector with beam angle (40°-60°) & anti-glare, clear glass diffuser to provide high Light efficiency.

الوصف ان سلسلة DLR66 عبارة عن مصابيح ليد مع هيكل من الالومنيوم المصبوب على الجودة ومغطى بالدهان ومعالج حراريا بناشر من الوبال الابيض ومانع للتوهج

## SPECIFICATIONS:

Model	Wattage	Lumen	Driver Type	D	H	Cut-Out Hole Size
LED-D661-7W	7W	840 Lm	Constant Current LED Driver	90mm	45mm	75mm
LED-D662-10W	10W	900 Lm	Constant Current LED Driver	135mm	50mm	115mm
LED-D663-15W	15W	1350 Lm	Constant Current LED Driver	165mm	55mm	145mm
LED-D664-25W-35W	25-35W	2225-3150 Lm	Constant Current LED Driver	220mm	65mm	195mm

## ILLUSTRATION

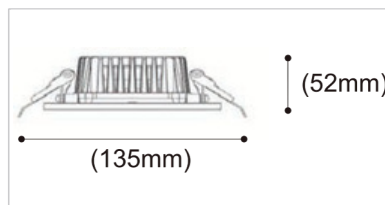

## LIGHT DISTRIBUTION

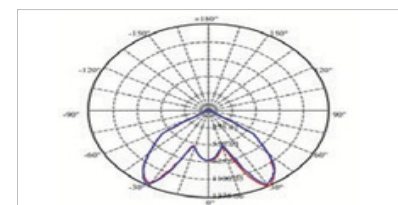

## OPTIONS:

-  Dimmable Driver 1-10 / DALI
-  Backup Emergency Kit 3Hr







# DLR61X IP65

## APPLICATIONS:

Suitable to be used in : hotels, reception room, restaurants, exhibitions, showrooms and commercial spaces.

التطبيقات  
مناسبة للاستخدام في : مناسبة للإستخدام في: الفنادق وغرفة الاستقبال والمطاعم والمعارض وصلالات العرض والمساحات التجارية





## General Specifications:

 Mounted	Ceiling recessed
 Material	Die casted aluminium
 IP	IP65
 50,000 Hrs ( L70 @ 25C° )	
 -20 : 45°C	
 warranty	5 Years

## Optical Data:

 chips	High Quality LED Chip
 COB SMD	SMD
 Lm	90 lm/W
 beam angle	110°
 CCT	3000K/4000K/6500K
 CRI	> 80

## Electrical Data:

 LED Wattage	18W/30W
 driver	Integrated LED constant cur.
 Voltage	(220-240) Vac
 HZ	50-60 Hz
 PF	> 0.95



## DESCRIPTIONS:

DLR61 IP65 is a Recessed LED downlight series with high quality diecast aluminum body in powder-coated, equipped with wide anti-glare, wide beam opal diffuser , available in different color temperature option. Excellent heat sink capability to minimize the luminous degradation, remote LED driver.

الوصف  
DLR61 IP65 عبارة عن سلسلة مصابيح ليد مع هيكل من الألمنيوم المصبوب عالي الجودة ومغطى بالدهان ، ومجهز بمشتمت عتيق عريض مضاد للوهج ، ومتوفر بخيار درجة حرارة ألوان مختلفة. قدرة ممتازة بالوعة الحرارة لتقليل تدهور الإضاءة ، محرك ليد عن بعد.

## SPECIFICATIONS:

Model	Wattage	Lumen	Driver Type	D	H	Cut-Out Hole Size
LED-D611-18W IP65	18W	1620 Lm	Constant Current LED Driver	140mm	54mm	120mm
LED-D612-30W IP65	30W	2700 Lm	Constant Current LED Driver	195mm	58mm	165mm

## ILLUSTRATION

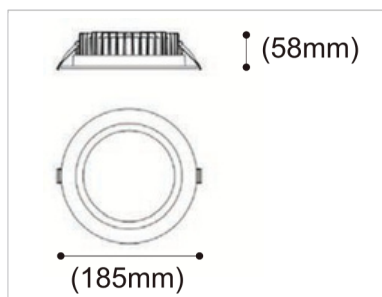

## LIGHT DISTRIBUTION

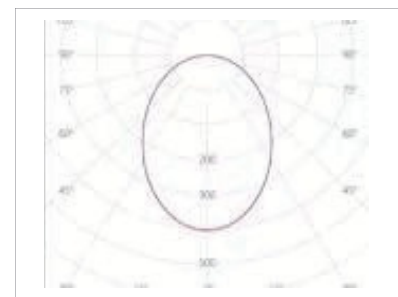

## OPTIONS:

-  Dimmable Driver 1 -10 / DALI
-  Backup Emergency Kit 3Hr





# DLR42 IP44

## APPLICATIONS:

Suitable to be used in : hotels, reception room, restaurants, exhibitions, showrooms and commercial spaces.

التطبيقات مناسبة للاستخدام في: الفنادق وغرفة الاستقبال والمطاعم والمعارض وصلالات العرض والمساحات التجارية



## DESCRIPTIONS:

DLR42 IP65 is a Recessed LED downlight series with high quality diecast aluminum body in powder-coated, equipped with wide anti-glare, wide beam , available in different color temperature option. Excellent heat sink capability to minimize the luminous degradation, remote LED driver.

## الوصف

DLR42 IP44 عبارة عن سلسلة مصابيح ليد مع هيكل من الألمنيوم المصبوب عالي الجودة ومغطى بالدهان ، ومجهز بمشمت عقيق عريض مضاد للوهج ، ومتوفر بخيار درجة حرارة ألوان مختلفة. قدرة ممتازة بالوعة الحرارة لتقليل تدهور الإضاءة ، محرك ليد عن بعد.





## General Specifications:

 Mounted	Ceiling recessed
 Material	Die casted aluminium
 IP	IP44
 50,000 Hrs ( L70 @ 25C° )	
 -20 : 45°C	
 warranty	5 Years

## Optical Data:

 chips	High Quality LED Chip
 COB SMD	SMD
 Lm	120 lm/W
 beam angle	15°/24°/36°/60°
 CCT	3000K/4000K/6500K
 CRI	> 80

## Electrical Data:

 LED Wattage	15W/20W/25W/30W
 driver	Integrated constant current
 Voltage	(220-240) Vac
 HZ	50-60 Hz
 PF	> 0.95

## SPECIFICATIONS:

Model	Wattage	Lumen	Driver Type	Ø	H	Cut-Out Hole Size
LED-D420-7W IP44	7W	900 Lm	Constant Current LED Driver	84mm	33mm	75mm
LED-D421-10W IP44	10W	1350 Lm	Constant Current LED Driver	105mm	42mm	95mm
LED-D422-15W IP44	15W	1800 Lm	Constant Current LED Driver	136mm	50mm	125mm
LED-D423-20W IP44	20W	2700 Lm	Constant Current LED Driver	162mm	58mm	150mm
LED-D424-25W/30W IP44	25/30W	3600 Lm	Constant Current LED Driver	213mm	66mm	200mm

## ILLUSTRATION

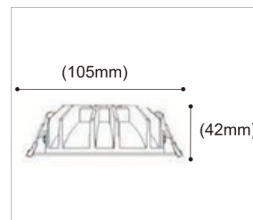

## LIGHT DISTRIBUTION

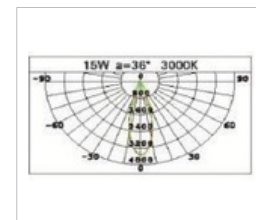

## OPTIONS:

-  Dimmable Driver 1-10 / DALI

 Backup Emergency Kit 3HR





# DLR48 IP40

## APPLICATIONS:

Suitable to be used in : hotels, reception room, restaurants, exhibitions, showrooms and commercial spaces.

التطبيقات  
مناسبة للاستخدام في : مناسبة للإستخدام في: الفنادق وغرفة الاستقبال والمطاعم والمعارض وصلالات العرض والمساحات التجارية





## General Specifications:

 Mounted	Ceiling recessed
 Material	Aluminium
 IP	IP40
 50,000 Hrs ( L70 @ 25C° )	
 -10 : 40°C	
 warranty	5 Years

## Optical Data:

 chips	High Quality LED Chip
 COB SMD	COB
 Lm	100 lm/W
 beam angle	15° , 24° , 36°
 CCT	3000K/4000K/6500K
 CRI	> 80

## Electrical Data:

 LED Wattage	15W/25W/35W
 driver	Built in
 Voltage	(220-240) Vac
 HZ	50-60 Hz
 PF	> 0.95



## DESCRIPTIONS:

DLR48 is a Recessed LED downlight series with high quality aluminum body in powder-coated, wide beam , available in different color temperature option. Excellent heat sink capability to minimize the luminous degradation, Integrated built in LED driver.

## الوصف

DLR42 عبارة عن سلسلة مصابيح ليد مع هيكل من الألمنيوم عالي الجودة ومغطى بالدهان ، ومجهز بمشتمت عتيق عريض مضاد للوهج ، ومتوفر بخيار درجة حرارة ألوان مختلفة. قدرة ممتازة بالوعة الحرارة لتقليل تدهور الإضاءة ، محرك ليد داخلي .

## SPECIFICATIONS:

Model	Wattage	Lumen	Driver Type	D	H	Cut-Out Hole Size
LED-D481-15W IP20	15W	1500 Lm	Constant Current LED Driver	130mm	69mm	75mm
LED-D482-24W IP20	24W	2400 Lm	Constant Current LED Driver	178mm	98mm	115mm
LED-D483-30W IP20	30W	3000 Lm	Constant Current LED Driver	237mm	128mm	200mm

## ILLUSTRATION

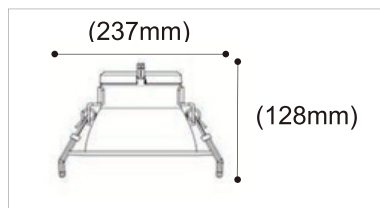

## LIGHT DISTRIBUTION

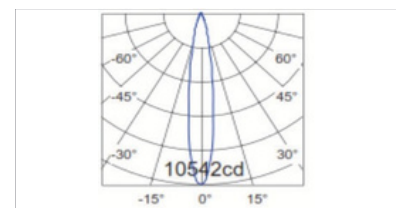

## OPTIONS:

-  Dimmable Driver 1-10 / DALI

 Backup Emergency Kit 3Hr





# DLR50 IP65

## APPLICATIONS:

Suitable to be used in : Canopy, outdoor courtyard and ceiling of indoor swimming rooms.

## التطبيقات

مناسبة للإستخدام فى : المظلات ، الفناء الخارجي وسقف غرف السباحة الداخلية





## General Specifications:

 Mounted	Ceiling Recessed
 Material	Die casted aluminium
 IP	IP65
 50,000 Hrs ( L70 @ 25C° )	
 -10 : 50°C	
 warranty	5 Years

## Optical Data:

 chips	High Quality LED Chip
 COB SMD	COB
 Lm	105 lm/W
 beam angle	24°/45°
 CCT	3000K/4000K/6500K
 CRI	> 90

## Electrical Data:

 LED Wattage	12W/20W
 driver	Integrated LED constant cur.
 Voltage	(220-240) Vac
 HZ	50-60 Hz
 PF	> 0.95



Recessed lighting



Black and White



Alum die casting

## DESCRIPTIONS:

DLR50 IP65 series is designed with powerful IP65 function, along with soft and bright visual effects, creating the interaction of light and shadow, fully presenting the charm of the space. Aqua series is ideal for entrance, stairway, bathrooms and outdoor corridor.

## الوصف

DLR50 IP65 هي عائلة تم تصميمها بوظيفة بدرجة حماية القوية جنابا إلى جنب مع تأثيرات بصرية ناعمة ومشرقة مما يخلق تفاعل الضوء والظل وهي مثالية للمداخل والسلام والحمامات والممر الخارجي

## SPECIFICATIONS:

Model	Wattage	Lumen	Beam Angle	Driver Type	Color Temperature	Ø	H
LED-D501-12W	12W	1260 Lm	24° / 45°	Constant Current LED Driver	3000K/4000K/6500K	92mm	80mm
LED-D502-20W	20W	2100 Lm	24° / 45°	Constant Current LED Driver	3000K/4000K/6500K	123mm	91mm

## SIZE | LED-D501-12W

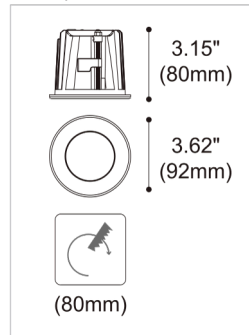

## SIZE | LED-D502-20W

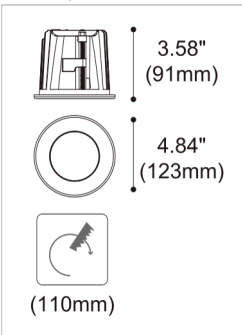

## LIGHT DISTRIBUTION

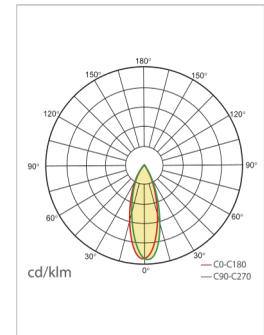

## OPTIONS:

-  Dimmable Driver 1-10 / DALI  Backup Emergency Kit 1H/3HR





# DLR51 IP44 & IP65

## APPLICATIONS:

Suitable to be used in : Canopy, outdoor courtyard and ceiling of indoor swimming rooms

## التطبيقات

مناسبة للإستخدام فى : المظلات ، الفناء الخارجي وسقف غرف السباحة الداخلية

## General Specifications:

	Ceiling Recessed
	Die casted aluminium
	IP44 / IP65
	50,000 Hrs ( L70 @ 25C° )
	-10 : 40°C
	5 Years

## Optical Data:

	High Quality LED Chip
	COB
	105 lm/W
	6°/10°/24°/36°/50°
	3000K/4000K/6500K
	> 90

## Electrical Data:

	7W/30W
	Integrated LED constant cur.
	(220-240) Vac
	50-60 Hz
	> 0.95



Fixed



Adjustable



Wallwash

## DESCRIPTIONS:

DLR51 IP44 & IP65 series is designed with powerful IP44 & IP65 function, along with soft and bright visual effects, creating the interaction of light and shadow, fully presenting the charm of the space. Aqua series is ideal for entrance, stairway, bathrooms and outdoor corridor.

## الوصف

DLR51 IP44 & IP65 هي عائلة تم تصميمها بوظيفة بدرجة حماية IP65 ، IP44 القوية ، جنباً إلى جنب مع تأثيرات بصرية ناعمة ومشرقة ، مما يخلق تفاعل الضوء والظل ، وهي مثالية للمداخل والسلاالم والحمامات والممر الخارجي.

## Easy Installation



Striped Glass Woven Glass Diffuser Honeycomb Louver

## OPTIONS:

- Dimmable Driver 1 -10 / DALI Backup Emergency Kit 1H/3HR

SIZE | LED-D511-7W

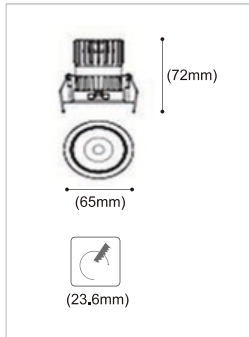

SIZE | LED-D512-7W

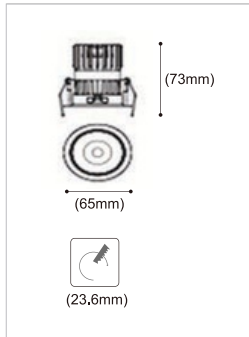

SIZE | LED-D513-10W

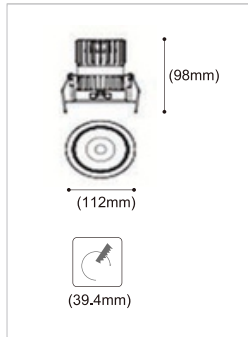

SIZE | LED-D514-25W

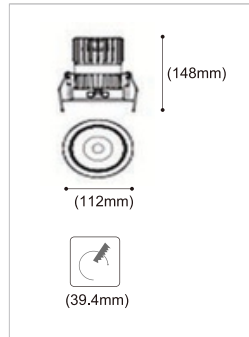

SIZE | LED-D515-10W

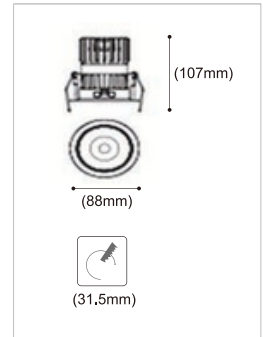

SIZE | LED-D516-10W

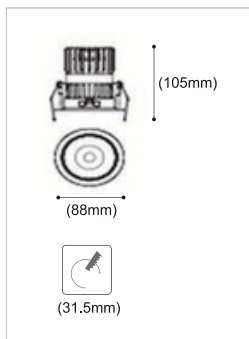

SIZE | LED-D517-10W

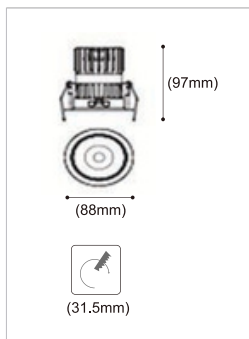

SIZE | LED-D518-30W

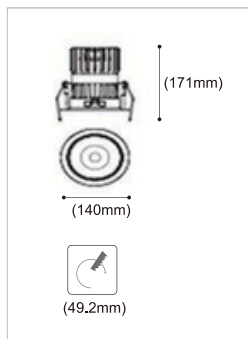

SIZE | LED-D519-30W

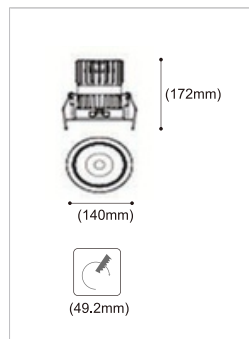

LIGHT DISTRIBUTION

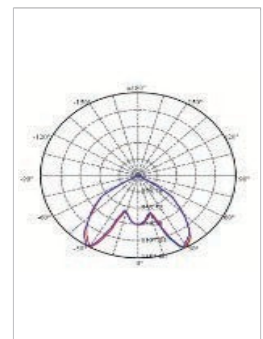

SPECIFICATIONS:

Model	Wattage	Lumen	Beam Angle	Driver Type	Color Temperature	Ø	H
LED - D511 IP65 Fixed - 7W	7W	735 Lm	10° / 24° / 36° / 50°	Constant Current LED Driver	3000K/4000K/6500K	65mm	72mm
LED - D512 IP65 Adjustable- 7W	7W	735 Lm	10° / 24° / 36° / 50°	Constant Current LED Driver	3000K/4000K/6500K	65mm	73mm
LED - D513 IP44 - 10W	10W	1050 Lm	10° / 24° / 36° / 50°	Constant Current LED Driver	3000K/4000K/6500K	112mm	98mm
LED - D514 IP44 - 25W	25W	2625 Lm	10° / 24° / 36° / 50°	Constant Current LED Driver	3000K/4000K/6500K	112mm	148mm
LED - D515 IP65 Fixed - 10W	10W	1050 Lm	10° / 24° / 36° / 50°	Constant Current LED Driver	3000K/4000K/6500K	88mm	107mm
LED - D516 IP65 Adjustable - 10W	10W	1050 Lm	10° / 24° / 36° / 50°	Constant Current LED Driver	3000K/4000K/6500K	88mm	105mm
LED - D517 IP65 Fixed - 10W	10W	1050 Lm	10° / 24° / 36° / 50°	Constant Current LED Driver	3000K/4000K/6500K	88mm	97mm
LED - D518 IP44 Fixed - 30W	30W	3150 Lm	10° / 24° / 36° / 50°	Constant Current LED Driver	3000K/4000K/6500K	140mm	171mm
LED - D519 IP44 Adjustable- 30W	30W	3150 Lm	10° / 24° / 36° / 50°	Constant Current LED Driver	3000K/4000K/6500K	140mm	172mm

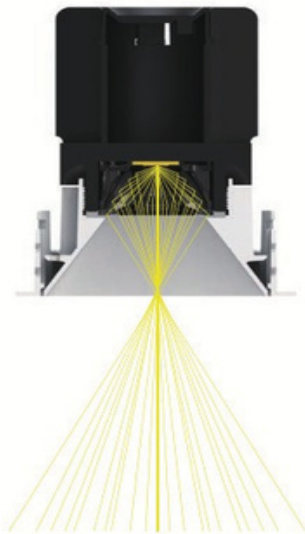



INDOOR

# SPOT LIGHT AND TRACK

**APPLICATIONS:**

Office, training room, conference room  
and classroom, etc.

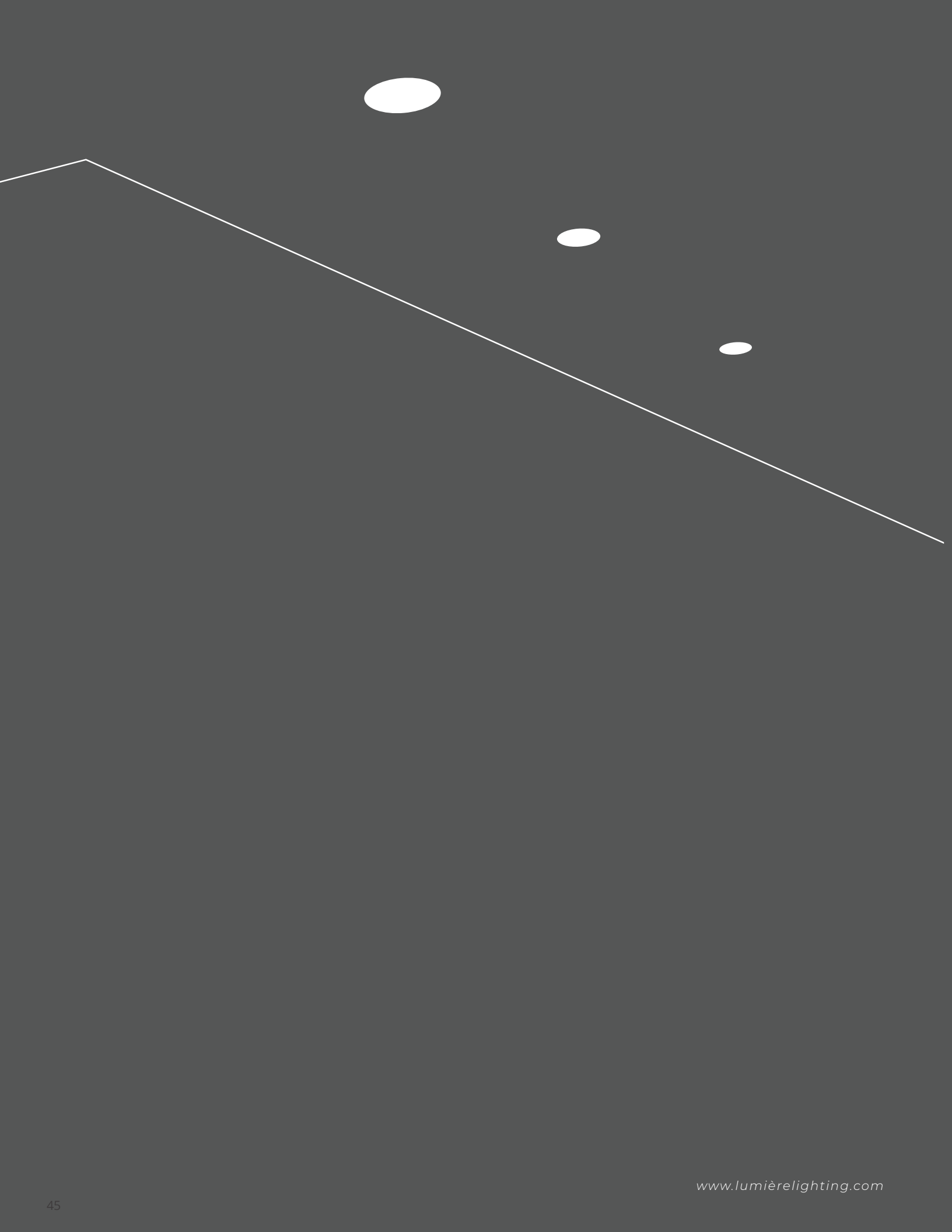





# LED - DLR16 IP40

## APPLICATIONS:

Suitable to be used in: offices, lobbies, entrances, showrooms corridors, circulation areas, stairs, waiting area in: clinics banks, governmental premises, general lighting applications. food production .

التطبيقات مناسبة للاستخدام في: المكاتب، الردهات، المداخل، صالات العرض، الممرات، مناطق الدوران، السلالم، مناطق الانتظار في: العيادات، البنوك، المباني الحكومية، وتطبيقات الإضاءة العامة.

## General Specifications:

	Ceiling Recessed
	Die casted aluminium
	IP 40
	50,000 Hrs (L70 @ 25C°)
	-10 : 40°C
	5 Years

## Optical Data:

	Bridgelux COB LED chips
	COB
	100 lm/W
	40° -60°
	3000K, 4000K, 6000K
	> 80

## Electrical Data:

	7W
	Integrated LED constant cur.
	(220-240) Vac
	50-60 Hz
	> 0.95



## DESCRIPTIONS:

DLR16 is a Recessed LED downlight with special super thin body design and has long life time more than 50,000 hrs with best power consumption and Performance. LED downlight especially designed to create general lighting solutions in houses, hotels, Offices, retail and all other similar applications. It's equipped with high efficient electronic driver and with high quality die-cast aluminum body . Unit provided with deep pure aluminum reflector with beam angle (40°-60°) & anti-glare, clear glass diffuser to provide high light efficiency.

## الوصف

D16X هو كشاف مدمج بتصميم خاص ذو جسم رفيع للغاية وذو عمر طويل يتجاوز 50,000 ساعة مع أفضل استهلاك للطاقة وأداء. كشاف مدمج مصمم خصيصاً لتوفير حلول الإضاءة العامة في المنازل، الفنادق، المكاتب، المتاجر وجميع التطبيقات المشابهة. يتميز بمزود طاقة إلكتروني عالي الكفاءة وفاقاً للمعايير السعودية والدولية مع جسم عالي الجودة من الألمنيوم المصبوب. الوحدة مزودة بعواكس من الألمنيوم النقي براوية شعاع (40°-60°) ومضاد للوهج، مع ناشر زجاجي شفاف لتوفير كفاءة إضاءة عالية.

## SPECIFICATIONS:

Model	Wattage	Light Source	Lumen	Driver Type	D	Cut-Out Hole Size	H
LED-D161-7W/3K/IP40	7W	Bridgelux COB	540 lm	350mA Constant Current LED Driver	90 mm	70 mm	50 mm
LED-D161-7W/4K/IP40	7W	Bridgelux COB	540 lm	350mA Constant Current LED Driver	90 mm	70 mm	50 mm
LED-D161-7W/6K/IP40	7W	Bridgelux COB	540 lm	350mA Constant Current LED Driver	90 mm	70 mm	50 mm

## ILLUSTRATION

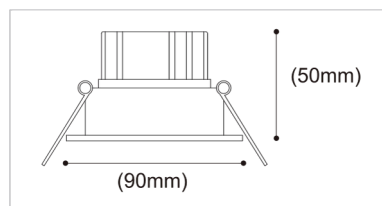

## LIGHT DISTRIBUTION

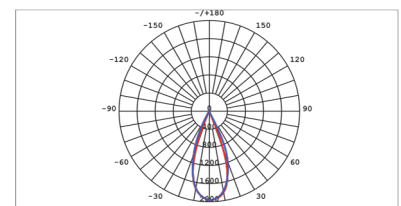

## OPTIONS:

– Dimmable Driver 1-10 / DALI

Backup Emergency Kit 1H/3H





# DLR58 IP65

## APPLICATIONS:

Suitable to be used in : hotels, reception room, restaurants, exhibitions, showrooms and commercial spaces.

التطبيقات مناسبة للاستخدام في: الفنادق، غرف الاستقبال، المطاعم، المعارض، صالات العرض والمساحات التجارية.

## General Specifications:

	Ceiling Recessed
	Cold Rolled Galvanized Steel
	IP65
	50,000 Hrs ( L70 @ 25C° )
	-10 : 40°C
	5 Years

## Optical Data:

	High Quality LED Chip
	COB
	100 lm/W
	15° , 24° , 36°
	3000K/4000K/6500K
	> 80

## Electrical Data:

	7W/10W/12W/15W
	Constant current LED driver
	(220-240) Vac
	50-60 Hz
	> 0.95



## DESCRIPTIONS:

DLR58 IP65 is a Recessed LED downlight with following specs :

The high efficiency reflector is developed via optic programming, using very simple designed-methods allow customers to change reflector angle easily. For more flexible, the major LED light set can be used with name brand LED source.

## الوصف

هو كشاف مدمج بتصميم خاص ذو جسم رفيع للغاية وذو عمر طويل يتجاوز 50,000 ساعة مع أفضل استهلاك للطاقة وأداء. كشاف مدمج مصمم خصيصاً لتوفير حلول الإضاءة العامة في المنازل، الفنادق، المكاتب، المتاجر وجميع التطبيقات المشابهة. يتميز بمزود طاقة إلكتروني عالي الكفاءة وفاقاً للمعايير السعودية والدولية مع جسم عالي الجودة من الألمنيوم المصبوب. الوحدة مزودة بعواكس من الألمنيوم النقي بزواوية شعاع (15°-36°) ومضاد للوهج، مع ناشر زجاجي شفاف لتوفير كفاءة إضاءة عالية.

## SPECIFICATIONS:

Model	Wattage	Light Source	Light Output & Beam Angle	Driver Type	D	H	Cut-Out Hole Size
LED-D581-7W IP65	7W	COB LED chips	700 lm - 15° , 24° , 36°	Constant Current LED Driver	76mm	69 mm	65 mm
LED-D582-10W IP65	10W	COB LED chips	1000 lm - 15° , 24° , 36°	Constant Current LED Driver	76mm	69 mm	65 mm
LED-D583-12W IP65	12W	COB LED chips	1200 lm - 15° , 24° , 36°	Constant Current LED Driver	92mm	93 mm	80 mm
LED-D584-15W IP65	15W	COB LED chips	1500 lm - 15° , 24° , 36°	Constant Current LED Driver	92mm	93 mm	80 mm

## ILLUSTRATION

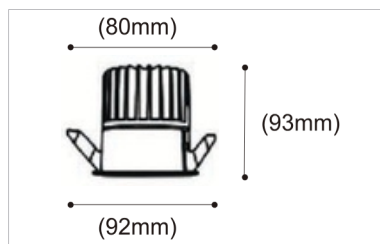

## LIGHT DISTRIBUTION

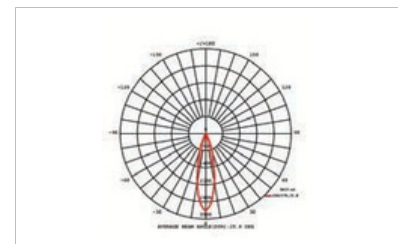

## OPTIONS:

- Dimmable Driver 1 -10 / DALI

Backup Emergency Kit 1H/3H





# LED - GL2 - 2X2W IP20

## APPLICATIONS:

Suitable to be used in : Hotels, Villas, Retail stores, Supermarkets, Restaurant and other places & etc .

التطبيقات مناسبة للاستخدام في : الفنادق والفيلاوات ومحلات البيع بالتجزئة ومحلات السوبر ماركت والمطاعم وغيرها من الأماكن.

## General Specifications:

	Ceiling Recessed
	Die casted aluminium body
	IP 20
	50,000 Hrs ( L70 @ 25C° )
	-10 : 40°C
	5 Years

## Optical Data:

	SMD 3030 LED chips
	SMD
	90 lm/W
	15°/25°/30°
	3000K/4000K/6500K
	>80

## Electrical Data:

	4 W
	Constant current LED driver
	(220-240) Vac
	50-60 Hz
	> 0.95



## DESCRIPTIONS:

LED GRID LIGHT - GL2-2X2W IP20 is a gridlight recessed luminaire Using dark light technology with seperated reflector and lens to achieve deep antiglare, with UGR<15. The housing made of excellent extrusion aluminum material with high efficient heat dissipation to do different size with no limit, to meet customers demands. It has a variality like a magic cube with different installation methods, with consistency of the light performance, a whole family .

## الوصف

إن LED GRID LIGHT - GL2-2X2W IP20 عبارة عن وحدة إنارة مجوفة بإضاءة شبكية تستخدم تقنية الإضاءة الداكنة مع عاكس منفصل وعدسة لتحقيق مقاومة عميقة للوهج ، مع UGR <15. الغلاف مصنوع من مادة الألمنيوم المبتنقة الممتازة مع تبديد حرارة عالي الكفاءة للقيام بأحجام مختلفة بلا حدود ، لتلبية متطلبات العملاء. لديها تنوع مثل المكعب السحري مع طرق تركيب مختلفة ، مع تناسق أداء الضوء ، سلسلة عائلية كاملة ، لتكون فريدة من نوعها ومعترف بها للغاية.

## SPECIFICATIONS:

Model	Wattage	Light Output	Driver Type	L	W	H	Cut Out
GL2-2X2W IP20	4W	216 lm	Constant Current LED	80 mm	46 mm	60 mm	72x42 mm

## ILLUSTRATION

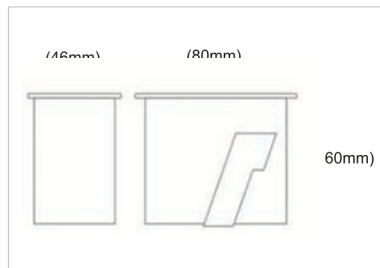

## LIGHT DISTRIBUTION

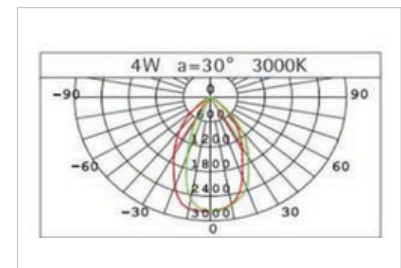

## OPTIONS:

- Dimmable Driver 1-10 / DALI

Backup Emergency Kit 1H/3H





# TR06 IP44

## APPLICATIONS:

Suitable to be used in : Spot lighting , Retail Store lighting, Commercial lighting, Residential lighting , General lighting & Energy Saving Programs, Sustainable Energy.

## التطبيقات

مناسب للاستخدام في: الإضاءة الموضعية، إضاءة المتاجر، الإضاءة التجارية، الإضاءة السكنية، الإضاءة العامة، برامج توفير الطاقة، والطاقة المستدامة.



## DESCRIPTIONS:

LED - TR06 IP44 Succinct housing design with hidden heatsink mechanism protects LED life. Multiple beam angles to choose from, easier for people to focus on the merchandise on the shelves. available in different sizes for a comfortable viewing experience.

## الوصف

إن LED - TR06X IP44 تصميم الجسيم مزود مع آلية خافض للحرارة يحمي حياة LED. زوايا شعاع متعددة للاختيار من بينها، مما يسهل على الأشخاص التركيز على البضائع الموجودة على الرفوف، متوفرة بأحجام مختلفة لتجربة مشاهدة مريحة.

## General Specifications:

	Ceiling Recessed
	Die casted aluminum
	IP44
	50,000 Hrs ( L70 @ 25C° )
	-10 : 40°C
	5 Years

## Optical Data:

	High Quality LED Chip
	SMD
	90 lm/W
	15°/24°/38°±3°
	3000K/4000K/6500K
	> 80

## Electrical Data:

	15W/25W/35W/45W
	Constant current LED driver
	(220-240) Vac
	50-60 Hz
	> 0.95

## SPECIFICATIONS:

Model	Wattage	Lumen	Beam Angle	Driver Type	Color Temoperature	Ø	H
LED-TR061-15W	15W	1350Lm	15°/24°/38°±3°	Constant Current LED Driver	3000K/4000K /6500K	60 mm	167 mm
LED-TR062-(20-25)W	(20-25)W	(1800-2250) Lm	15°/24°/38°±3°	Constant Current LED Driver	3000K/4000K /6500K	70 mm	170 mm
LED-TR063-(30-35)W	(30-35)W	(2700-3150)W	15°/24°/38°±3°	Constant Current LED Driver	3000K/4000K /6500K	80 mm	177 mm
LED-TR064-(40-45)W	(40-45)W	(3600-4050)W	15°/24°/38°±3°	Constant Current LED Driver	3000K/4000K /6500K	90 mm	182 mm

## ILLUSTRATION

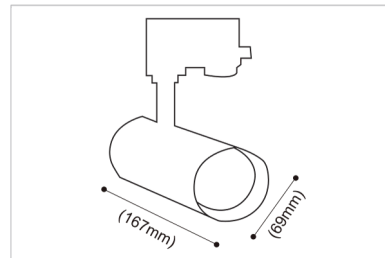

## LIGHT DISTRIBUTION

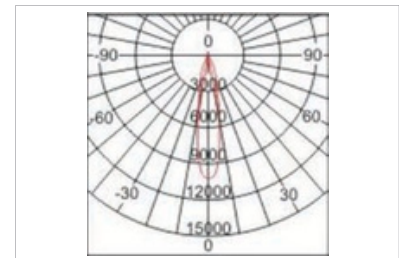

## OPTIONS:

- Dimmable Driver 1-10 / DALI

Backup Emergency Kit 1H/3H

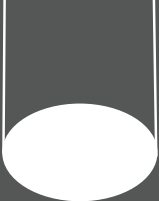

INDOOR

# SURFACE DOWN LIGHT

**APPLICATIONS:**

Office, training room, conference room  
and classroom, etc.







# CM04 IP54

## APPLICATIONS:

Public areas such as stairway, lobby, reception, corridors etc.

التطبيقات  
المناطق العامة مثل السلالم، الردهة، الاستقبال، الممرات، وما إلى ذلك.

## General Specifications:

Mounted	Ceiling Recessed
Material	Cold Rolled Galvanized Steel
IP	IP54
Life	50,000 Hrs ( L70 @ 25C° )
Temperature	-10 : 40°C
Warranty	5 Years

## Optical Data:

chips	High Quality LED Chip
COB SMD	SMD
Lm	100 lm/W
beam angle	90°
CCT	3000K/4000K/6500K
CRI	> 80

## Electrical Data:

LED Wattage	15W/18W
driver	Constant current LED driver
Voltage	(220-240) Vac
HZ	50-60 Hz
PF	> 0.95



## DESCRIPTIONS:

LED CM04X is a surface mounted ceiling light adopts high lumen SMD LED, PMMA diffuser with even light output. IP54 waterproof structural design, it is an ideal replacement for damp location.

الوصف  
LED CM04X هو ضوء سقفي مثبت على السطح يتميز بالمواسفات التالية:

مزدود بموزع من PMMA لضمان توزيع الضوء بشكل متساوي. تصميم هيكلي مقاوم للماء بمعدل IP54، مما يجعله بديلاً مثالياً للأماكن الرطبة.

## SPECIFICATIONS:

Model	Wattage	Lumen	IP Rate	Beam Angle	Ø	H
CM041-15W	15W	1500LM	IP54	90°	170	68
CM042-18W	18W	1800LM	IP54	90°	170	68

## ILLUSTRATION

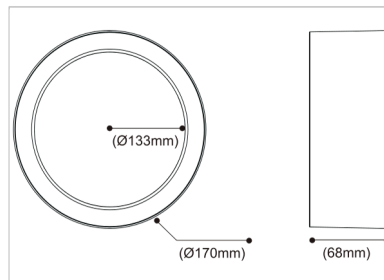

## LIGHT DISTRIBUTION

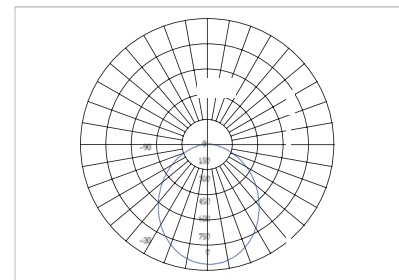

## OPTIONS:

- Dimmable Driver 1-10 / DALI

Backup Emergency Kit 1H/3H





# LED - D56X IP20

## APPLICATIONS:

Suitable to be used in : hospitals, laboratories, pharmaceutical production and

## التطبيقات

مناسبة للاستخدام في : المستشفيات، المختبرات، إنتاج الأدوية وإنتاج الأغذية.





## General Specifications:

 Mounted	Ceiling Recessed
 Material	Cold Rolled Galvanized Steel
 IP	IP54/55
 50,000 Hrs ( L70 @ 25C° )	
 -10 : 40°C	
 warranty	5 Years

## Optical Data:

 chips	High Quality LED Chip
 COB SMD	SMD
 Lm	100 lm/W
 beam angle	90°
 CCT	3000K/4000K/6500K
 CRI	> 80

## Electrical Data:

 LED Wattage	10W
 driver	Constant current LED driver
 Voltage	(220-240) Vac
 HZ	50-60 Hz
 PF	> 0.95



## DESCRIPTIONS:

Surface LED downlight with following specs :

- Anti-glare reflector create visual comfort.
- Simplified and elegant style.
- Different angles of reflector for different lighting requirements.
- LED life time: >50000h with L80.
- Aluminium body for good thermal management.
- Suitable to the high quality COB light source.

## الوصف

الضوء السطحي الأسطواني D56X IP20 هو ضوء سطحي بمواصفات كالتالي:  
 • عاكس مضاد للتوهج يخلق راحة بصرية.  
 • تصميم مبسط وأنيق.  
 • زوايا مختلفة للعاكس لتلبية متطلبات الإضاءة المختلفة.  
 • إعادة إنتاج ممتازة للألوان، متوفرة بدرجات  
 • جسم من الألومنيوم لإدارة حرارية جيدة.

## SPECIFICATIONS:

Model	Wattage	Light Source	Light Output	Driver Type	D	H
LED-SU D561-10W	10W	COB LED chips	1000 lm	Constant Current LED Driver	100 mm	122 mm

## ILLUSTRATION

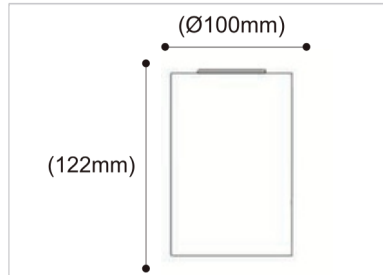

## LIGHT DISTRIBUTION

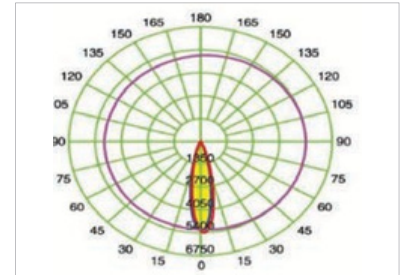

## OPTIONS:

–  Dimmable Driver 1-10 / DALI

 Backup Emergency Kit 1H/3H



INDOOR

# INDUSTRIAL LIGHTING

**APPLICATIONS:**

Parking, laboratory room

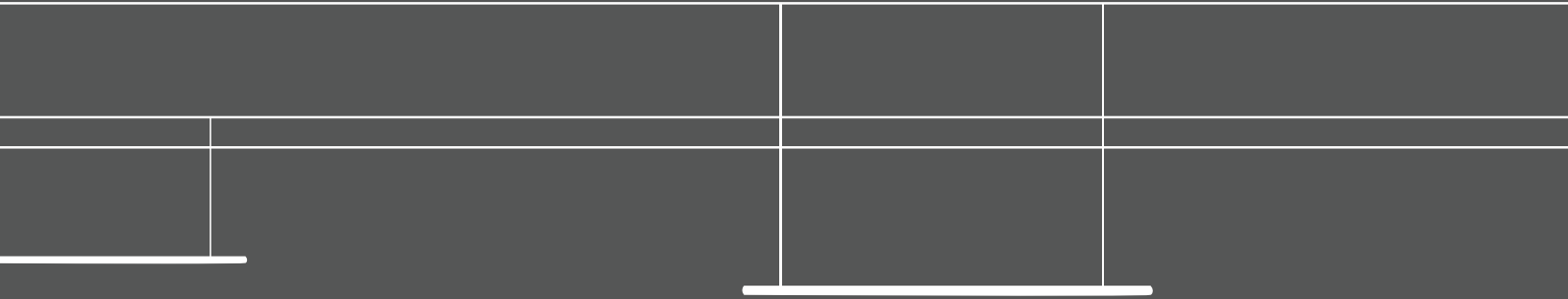





# LED - WAT IP65

## APPLICATIONS:

Suitable to be used in : Office, Residential, commercial and other indoor lighting applications. food production .

التطبيقات مناسبة للاستخدام في : المكاتب و الوحدات السكنية والتجارية وغيرها من تطبيقات الإضاءة الداخلية.





## General Specifications:

 Mounted	Ceiling / Wall Mounted
 Material	Cold Rolled Galvanized Steel
 IP	IP65
 50,000 Hrs ( L70 @ 25C° )	
 -10 : 40°C	
 warranty	5 Years

## Optical Data:

 chips	High Quality LED Chip
 COB SMD	SMD
 Lm	100 lm/W
 beam angle	°120
 CCT	3000K/4000K/6500K
 CRI	> 80

## Electrical Data:

 LED Wattage	24W/40W/48W/72W
 driver	Constant current LED driver
 Voltage	(220-240) Vac
 HZ	50-60 Hz
 PF	> 0.95



## DESCRIPTIONS:

WAT-LED-18/25/36/50W- IP65 is a surface mounted luminaire that offers high ingress protection against dust and jetting water . The housing and diffuser is made of PC material .High LOR reaches 69%. DIAL certified photometry. Energy efficiency is obtained using an electronic ballast with PF higher than 0.95.

## الوصف

هي وحدة إنارة مثبتة على السطح توفر حماية عالية ضد دخول الغبار و المياه . الجسم والناشر مصنع من مادة البلاستيك البولي كربونيت ويتم الحصول على أعلى كفاءة استخدام للطاقة بواسطة إستخدام وحدة تحكم إلكترونية تعطي معامل قدرة أعلى من 0.95

## SPECIFICATIONS:

Model	Wattage	Lumen	Driver Type	L	W	H
	18W	1530 Lm	Constant Current LED Driver	650mm	90 mm	68 mm
WAT-LED-18WE/PC WAT-LED-25WE/PC	25W	2125 Lm	Constant Current LED Driver	650mm	90 mm	68 mm
WAT-LED-36WE/PC	36W	3060 Lm	Constant Current LED Driver	1220mm	90 mm	68 mm
WAT-LED-50WE/PC	50W	4250 Lm	Constant Current LED Driver	1260mm	90 mm	168 mm

## ILLUSTRATION

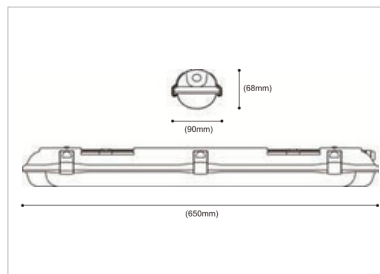

## LIGHT DISTRIBUTION

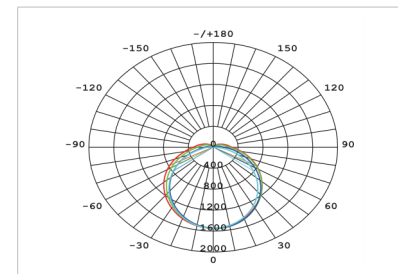

## OPTIONS:

-  Dimmable Driver 1 -10 / DALI



Backup Emergency Kit 1H/3H

The background is a dark grey color. It features several white, elongated, rectangular shapes that appear to be light fixtures or beams of light, arranged in a scattered pattern. A thin white line runs horizontally across the middle of the page, with a slight dip in the center. On the right side, there is a vertical white outline of a rectangular column.

INDOOR

# WRAPARROUND LIGHT

**APPLICATIONS:**

Offices, Class room

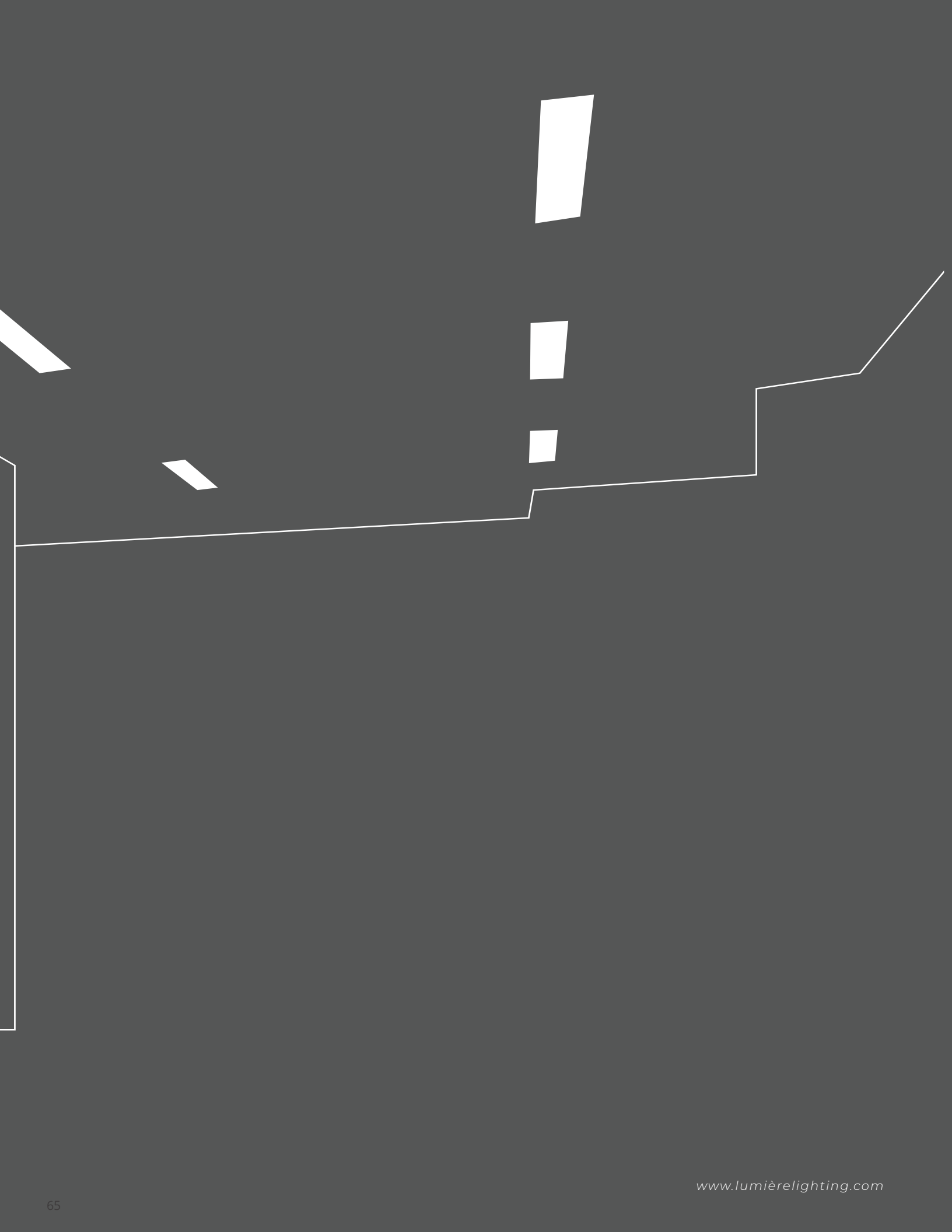





# FULLY WRR IP44

## APPLICATIONS:

Suitable to be used in : Schools, hospitals, and all other similar applications. food production .

## التطبيقات

مناسبة للاستخدام في : المدارس والمستشفيات وجميع التطبيقات المماثلة الأخرى





## General Specifications:

 Mounted	Surface & Wall mounted
 Material	PC
 IP	IP40
 50,000 Hrs ( L70 @ 25C° )	
 -10 : 40°C	
 warranty	5 Years

## Optical Data:

 chips	High Quality LED Chip
 COB SMD	SMD
 Lm	100 lm/W
 beam angle	120°
 CCT	3000K/4000K/6500K
 CRI	> 80

## Electrical Data:

 LED Wattage	24W/40W/50W
 driver	Constant current LED driver
 Voltage	(220-240) Vac
 HZ	60 Hz
 PF	> 0.95



## DESCRIPTIONS:

FULLY WRR IP44 is a decorative surface mounted wrap around LED luminaire coming with high efficient electronic driver as per Saudi and international standards. The housing is made of steel housing finished with 3-stages pretreatment electrostatic powder coating . The luminaire has polycarbonate covers (opal) which gives more light uniformity.

## الوصف

هي وحدة إضاءة ديكورية مثبتة على السطح بتصميم يلتف حوله، تأتي مزودة بمشغل إلكتروني عالي الكفاءة وفاقا للمعايير السعودية والدولية. الهيكل مصنوع من الفولاذ ومطلي بطبقة طلاء إلكتروستاتيكي عبر عملية معالجة من 3 مراحل. تحتوي الوحدة على أعطية من البولي كربونات (أوبال) التي توفر توزيعاً أكثر توازناً للضوء.

## SPECIFICATIONS:

Model	Wattage	Lumen	Driver Type	L	W	H
LED FULLY WRR - 24W	24W	2400 Lm	Constant Current LED Driver	700mm	168mm	54mm
LED FULLY WRR - 40W	40W	4000 Lm	Constant Current LED Driver	700mm	168mm	54mm
LED FULLY WRR - 40W	40W	4000 Lm	Constant Current LED Driver	1200mm	168mm	54mm
LED FULLY WRR - 40W	50W	5000 Lm	Constant Current LED Driver	1200mm	168mm	54mm

## ILLUSTRATION

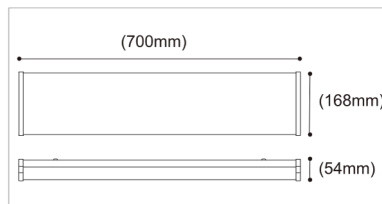

## LIGHT DISTRIBUTION

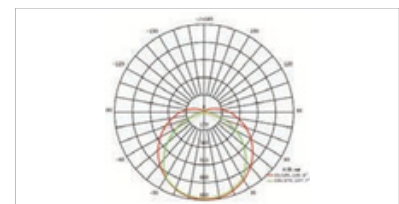

## OPTIONS:

-  Dimmable Driver 1-10 / DALI



Backup Emergency Kit 1H/3H

INDOOR

# MIRROR LIGHT

**APPLICATIONS:**

Toilets and wash rooms,

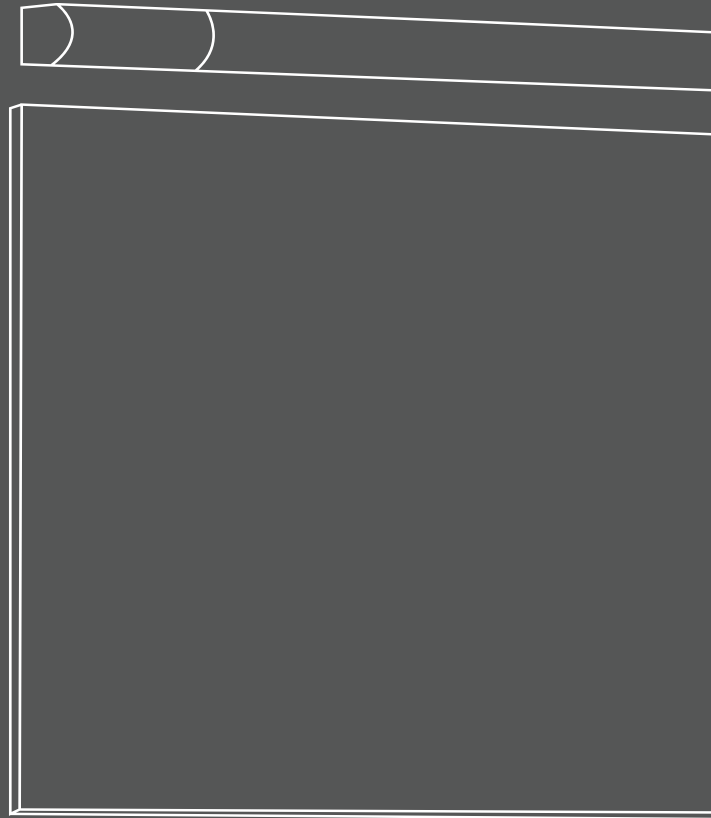

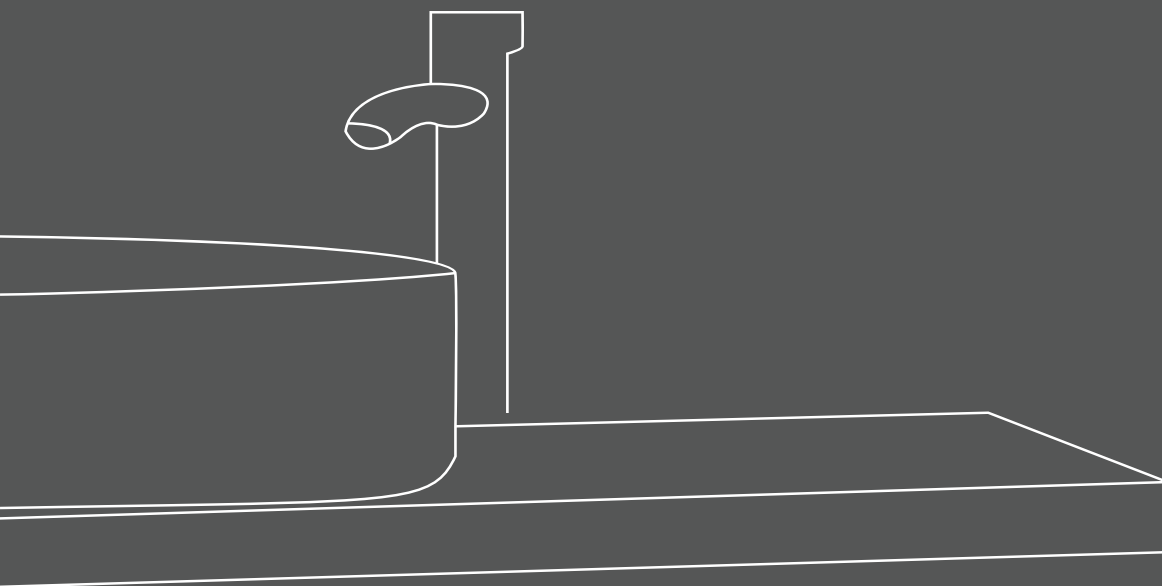
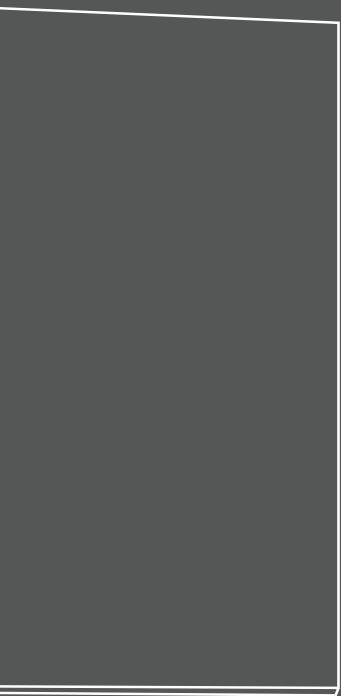





# MIRROR IP44

## APPLICATIONS:

Suitable to be used in : Toilets and wash rooms.food production .

## التطبيقات

مناسبة للاستخدام في : الحمامات وغرف غسل





## General Specifications:

 Mounted	Surface/Wall
 Material	Aluminum with anti UV powder coating
 IP	IP 44
 (35,000 - 50,000) Hrs ( L70 @ 40C°)	
 -10 : 40°C	
 warranty	5 Years

## Optical Data:

 chips	High Quality LED Chip
 COB SMD	COB
 Lm	85 lm/W
 beam angle	120°
 CCT	3000K/4000K/5000K/6500K
 CRI	> 80

## Electrical Data:

 LED Wattage	9W/15W/20W
 driver	Constant current LED driver
 Voltage	(220-240) Vac
 HZ	60 Hz
 PF	> 0.95



## DESCRIPTIONS:

ABOVE MIRROR IP44 is a surface wall mounted luminaire of 0.6 mm steel housing finished with 3-stages pretreatment electrostatic powder coating. Plastic diffuser material is PMMA. Energy efficiency is obtained using electronic ballast with PF higher than 0.95.

## الوصف

هي وحدة إنارة مثبتة على الحائط بسطح فولاذي 0.6 مم مطلية بطبقة من الطلاء الإليكتروستاتيكي من ثلاث مراحل. مادة ناشر البلاستيك هي . يتم الحصول على كفاءة الطاقة باستخدام محول إلكتروني مع معامل قدرة أعلى من 0.95

## SPECIFICATIONS:

Model	Wattage	Lumen	Driver Type	L	W	H
LED - NML - 9W	9W	765 Lm	Constant Current LED Driver	600 mm	53 mm	65 mm
LED - NML - 15W	15W	1275 Lm	Constant Current LED Driver	600 mm	53 mm	65 mm
LED - NML - 20W	20W	1700 Lm	Constant Current LED Driver	900 mm	53 mm	65 mm

## ILLUSTRATION

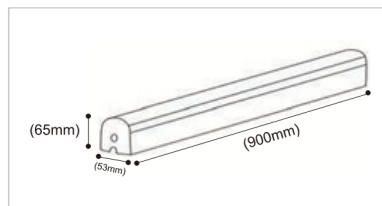

## LIGHT DISTRIBUTION

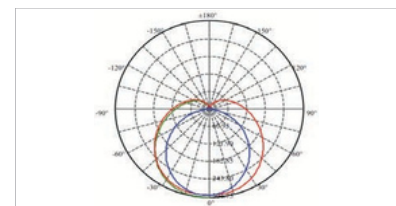

## OPTIONS:

-  Dimmable Driver 1-10 / DALI



Backup Emergency Kit 1H/3H



INDOOR

# LINEAR LIGHT

**APPLICATIONS:**

Offices and Reception







# Circular Ring IP40

## APPLICATIONS:

Suitable to be used in : Offices and Reception

## التطبيقات

مناسبة للاستخدام في: المكاتب والاستقبال





## General Specifications:

 Mounted	Ceiling Suspended
 Material	Cold Rolled Galvanized Steel
 IP	IP 40
 (35,000 - 50,000) Hrs ( L70 @ 40C°)	
 -25 °C < TA < 50 °C	
 warranty	5 Years

## Optical Data:

 chips	High Quality LED Chip
 COB SMD	SMD
 Lm	100 Lm/W
 beam angle	120°
 CCT	Optional
 CRI	> 80

## Electrical Data:

 LED Wattage	36W/58W/75W
 driver	built-in
 Voltage	(200-240) Vac
 HZ	50-60 Hz
 PF	>0.9

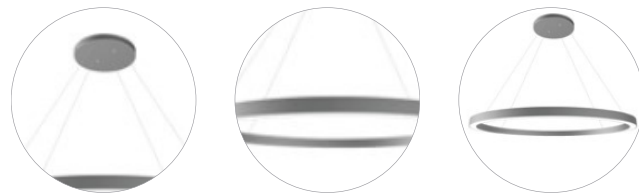

## DESCRIPTIONS:

Simple and light weight lamp body structure, easy to installation and disassembly. Precise optical design, pure light color, perfect light spot to create excellent lightings. Integrated high grade LED Driver with stable performance and longer lifespan. Die-casting aluminum housing is durable, with white powder spraying on the surface.

## الوصف

هيكل جسم المصباح بسيط وخفيف الوزن، سهل التركيب والتفكيك. تصميم بصري دقيق، لون فاتح نقي. متكامل عالي الجودة مع أداء مستقر وعمر LED نقطة إضاءة مثالية للإنشاء أضواء ممتازة. برنامج تشغيل أطول. غلاف الألمنيوم المصبوب.

## SPECIFICATIONS:

Watt	Power Factor	Dimention	Lumen	Output Current
36W, 58W, 75W	>0.9	Customized	3396, 5094, 6792 Lm	650mA

## ILLUSTRATION

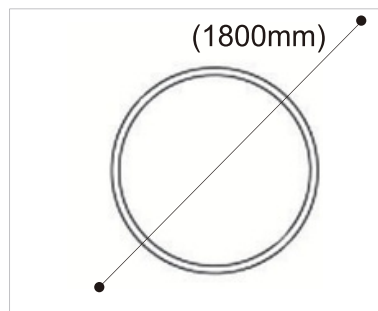

## LIGHT DISTRIBUTION

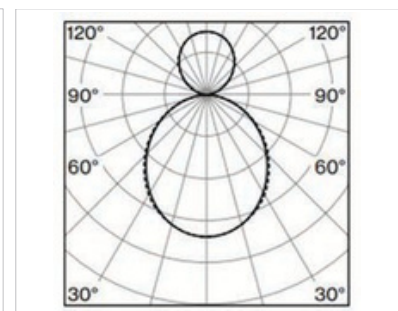

## OPTIONS:

-  Dimmable Driver 1 -10 / DALI

 Backup Emergency Kit 1H/3H





# LINEAR RD95 IP44

## APPLICATIONS:

Suitable to be used in : Offices, meeting rooms, conference halls other similar applications.

التطبيقات المناسبة للاستخدام في : المكاتب و قاعات الاجتماعات و قاعات المؤتمرات و غيرها من التطبيقات المشابهة





## General Specifications:

 Mounted	Ceiling recessed
 Material	Extruded aluminum
 IP	IP 44
 50,000 Hrs (L70@25C°)	
 -10 : 40°C	
 warranty	5 Years

## Optical Data:

 chips	LED SMD Chips
 COB SMD	SMD
 Lm	100 Lm/W
 beam angle	120°
 CCT	3000K/4000K/6500K
 CRI	> 80

## Electrical Data:

 LED Wattage	12W/24W/36W/50W
 driver	Constant current LED driver
 Voltage	(220-240) Vac
 HZ	50-60 Hz
 PF	>0.95



## DESCRIPTIONS:

The PROLINE Rd95 is the new slim Recessed LED lighting system that provides an ultra narrow luminaire which can be configured in a multitude and different ways by all concepts. Its clever yet simple design enables the lighting designer to create unique lighting solution without compromising on lighting performance. This family can be installed individually or as a continuous line.

## الوصف

هو نظام الإضاءة الجديد النحيف الذي يوفر وحدة إنارة ضيقة جداً يمكن تهيئتها بطرق متعددة ومختلفة حسب جميع المفاهيم. يتيح تصميمه الذكي والبسيط لمصمم الإضاءة إنشاء حل إضاءة فريد دون المساس بأداء الإضاءة. يمكن تثبيت هذه العائلة بشكل فردي أو كخط مستمر.

## SPECIFICATIONS:

CODE	Wattage	Lumen	IP Rate	L	W	H
LINEAR Rd 95 12W LED	12W	1200LM	IP40	610mm	95mm	75mm
LINEAR Rd 95 24W LED	24W	2400LM	IP40	1210mm	95mm	75mm
LINEAR Rd 95 36W LED	36W	3600LM	IP40	1210mm	95mm	75mm
LINEAR Rd 95 50W LED	50W	5000LM	IP40	1210mm	95mm	75mm

## ILLUSTRATION

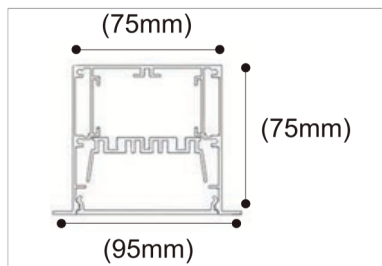

## LIGHT DISTRIBUTION

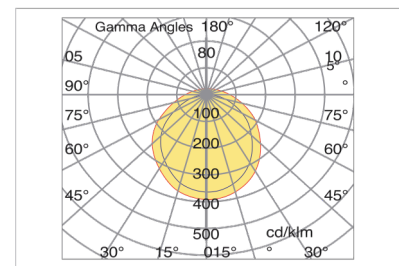

## OPTIONS:

-  Dimmable Driver 1-10 / DALI

 Backup Emergency Kit 1H/3H



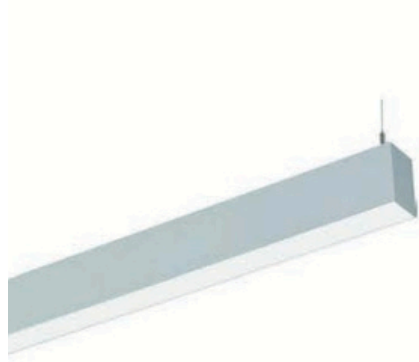

# LINEAR CD 90

## APPLICATIONS:

Suitable to be used in : Offices, meeting rooms and conference halls.

## التطبيقات

مناسبة للاستخدام في : المكاتب وقاعات الاجتماعات وقاعات المؤتمرات .





## General Specifications:

 Mounted	Ceiling Surface /Pendant
 Material	Die casted aluminium
 IP	IP 44
 50,000 Hrs ( L70 @ 25C° )	
 -10 : 40°C	
 warranty	5 Years

## Optical Data:

 chips	High Quality LED Chip
 COB SMD	SMD
 Lm	100 Lm/W
 beam angle	120°
 CCT	3000K/4000K/6500K
 CRI	> 80

## Electrical Data:

 LED Wattage	12W/24W/36W/50W
 driver	Constant current LED driver
 Voltage	(220-240) Vac
 HZ	50-60 Hz
 PF	> 0.95



## DESCRIPTIONS:

The LINEAR Cd 90 is the new slim Surface /Pendant LED lighting system that provides an ultra narrow luminaire which can be configured in a multitude and different ways by all concepts. Its clever yet simple design enables the lighting designer to create unique lighting solution without compromising on lighting performance. This family can be installed individually or as a continuous line

## الوصف

LINEAR Cd90 هو نظام إضاءة LED نحيف يتم تركيبه على السطح أو بشكل معلق، ويوفر تركيبات إضاءة ضيقة للغاية يمكن تكوينها بطرق متعددة ومختلفة لتناسب جميع المفاهيم. يتيح تصميمه الذكي والبسيط لمصمم الإضاءة إنشاء حلول إضاءة فريدة دون التأثير على أداء الإضاءة. يمكن تركيب هذه السلسلة بشكل فردي أو كخط إضاءة مستمر.

## SPECIFICATIONS:

Model	Wattage	Lumen	IP Rate	L	W	H
LINEAR Cd 90 12W LED	12W	1200LM	IP40	610mm	90mm	75mm
LINEAR Cd 90 24W LED	24W	2400LM	IP40	1210mm	90mm	75mm
LINEAR Cd 90 36W LED	36W	3600LM	IP40	1210mm	90mm	75mm
LINEAR Cd 90 50W LED	50W	5000LM	IP40	1210mm	90mm	75mm

## ILLUSTRATION

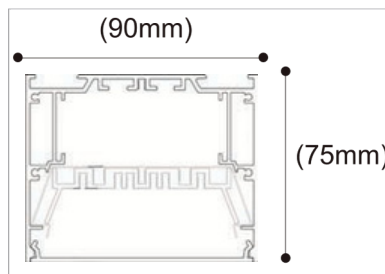

## LIGHT DISTRIBUTION

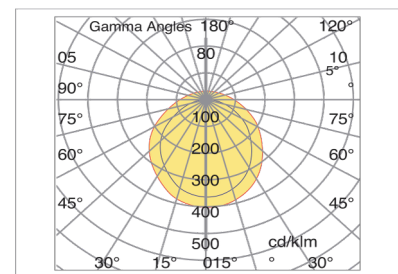

## OPTIONS:

-  Dimmable Driver 1-10 / DALI

 Backup Emergency Kit 1H/3H

INDOOR

# EMERGENCY LIGHT

**APPLICATIONS:**

Schools, offices and passages, hospitals, parking and theatres .

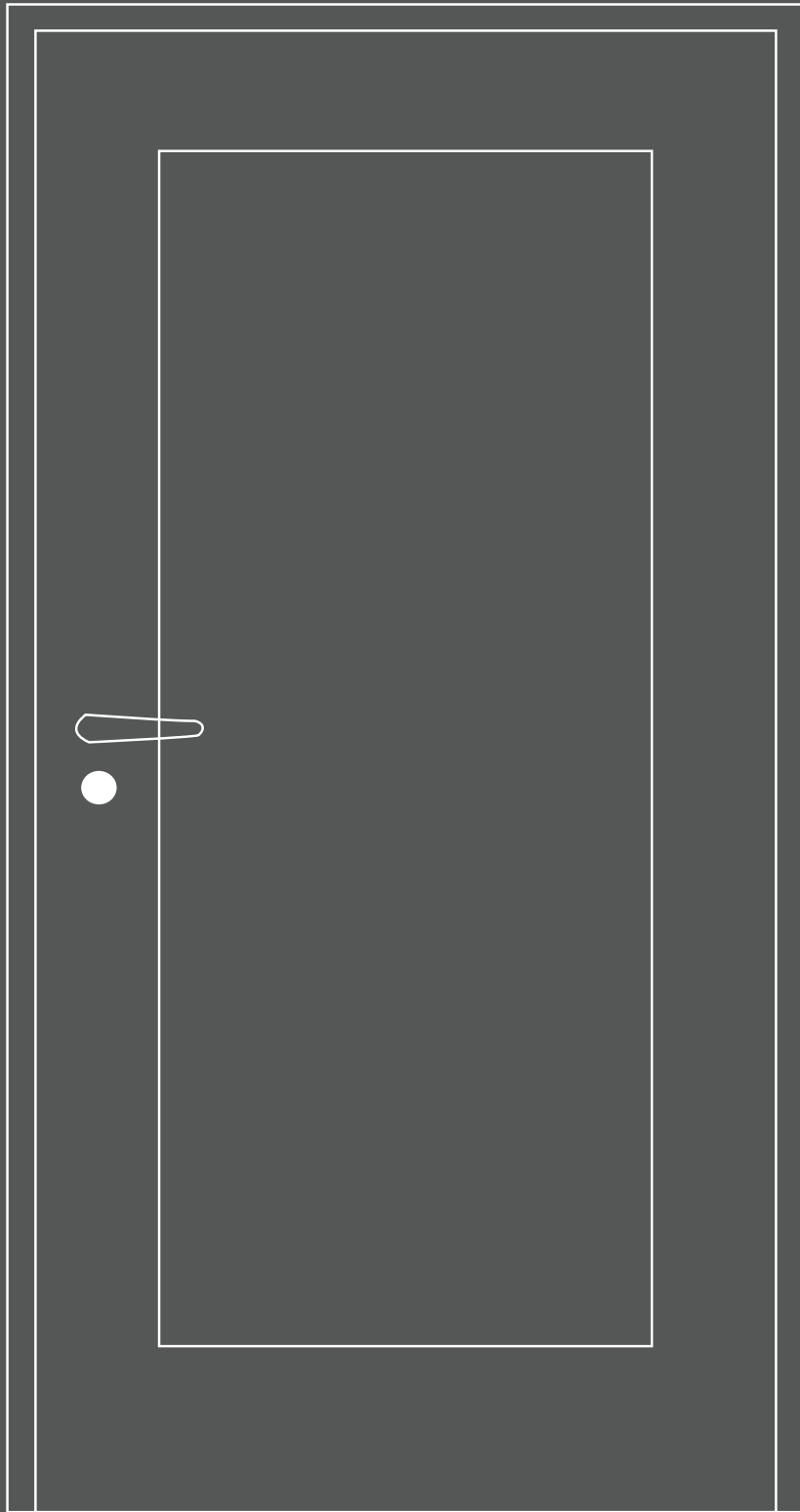





# EXIT IP20

## APPLICATIONS:

Suitable to be used in : Schools, offices and passages, hospitals, parking and theatres .

## التطبيقات

مناسبة للاستخدام في : المدارس والمكاتب والممرات والمستشفيات ومواقف السيارات والمسارح.

## General Specifications:

Mounted	Wall/Ceiling/Recessed
Material	Steel Housing
IP	IP 20
	50,000 Hrs ( L70 @40C° )
	-5 : 40°C
warranty	5 Years

## Optical Data:

chips	High Quality LED Chip
COB SMD	SMD
Lm	25
beam angle	-
CCT	GREEN
CRI	> 80

## Electrical Data:

LED Wattage	3W
driver	Electronic LED driver
Voltage	(220-240) Vac
HZ	50-60 Hz
PF	> 0.5



## DESCRIPTIONS:

Exit is a multi mounting exit sign (Wall/Ceiling/Recessed/Suspended) of steel housing finished with 3-stages pretreatment electrostatic powder coating with Maintained and Non-Maintained 3 hrs Emergency Kit. (1.5 Hr. as option). This type is suitable for all types of walls and ceilings.

## الوصف

عبارة عن علامة خروج متعددة التركيب (الجدار / السقف / الغائرة / المعلقة) من غلاف فولاذي منتهية بطبقة مسحوق إلكتروستاتيكية معالجة مسباقا على 3 مراحل مع مجموعة طوارئ تمت صيانتها وغير صيانتها لمدة 3 ساعات. (1.5 ساعة كخيار). هذا النوع مناسب لجميع أنواع الجدران والأسقف.

## SPECIFICATIONS:

Code	Wattage	IP Rate	L	W	H
EXIT [WAL/METAL] M / NM-3hr LED-3W - ARABIC/ ENGLISH [WH]	3W	IP20	340mm	457mm	156mm
EXIT [CEILING/METAL] M / NM-3hr LED-3W - ARABIC/ENGLISH [WH]	3W	IP20	340mm	457mm	156mm
EXIT [REC/METAL] M / NM-3hr LED-3W - ARABIC/ ENGLISH [WH]	3W	IP20	340mm	457mm	156mm
EXIT [SUS/METAL] M / NM-3hr LED-3W - ARABIC/ ENGLISH [WH]	3W	IP20	340mm	457mm	156mm

## ILLUSTRATION

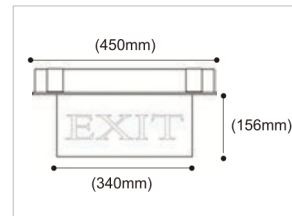

## OPTIONS:

- Dimmable Driver 1-10 / DALI
- Backup Emergency Kit 1H/3H





# Emergency TWIN LIGHT IP65

LED Emergency Twin Light

## APPLICATIONS:

Suitable to be used in : Schools, offices, dormitories and other similar applications .

## التطبيقات

مناسبة للاستخدام في : المدارس والمكاتب والمهاجع وغيرها من التطبيقات المماثلة.





## General Specifications:

 Mounted	Wall mounted
 Material	Poly Carbonate / STEEL
 IP	IP 65
 50,000 Hrs ( L70 @40C° )	50,000 Hrs ( L70 @40C° )
 -5 : 40°C	-5 : 40°C
 warranty	5 Years

## Optical Data:

 chips	High Quality LED Chip
 COB SMD	SMD
 Lm	25
 beam angle	-
 CCT	4000K
 CRI	> 80

## Electrical Data:

 LED Wattage	2x9W
 driver	Electronic LED driver
 Voltage	(220-240) Vac
 HZ	50-60 Hz
 PF	> 0.5



## DESCRIPTIONS:

STANDARD EM S is an emergency light especially designed to show occupants within a facility where they can exit in case of a fire or other emergency usually located in doorways, rooms and passages. It is equipped with an 2X9W led lamp. Viewing distance is up to 30 meters. The housing is made of white powder coated steel.

## الوصف

هو مصباح طوارئ مصمم خصيصا لظهور اماكن داخل المنشأة حيث يمكنهم الخروج في حالة نشوب حريق او حالة طوارئ اخرى تقع عادة في المداخل والغرف والممرات. وهي مجهزة بمصباح منسافة الرؤية تصل إلى 30 مترا. الهيكل مصنوع من الفولاذ المطلي بمسحوق ابيض.

## SPECIFICATIONS:

Model	Wattage	Lumen	IP Rate	L	W	H
EM S [WALL/METAL] NM-3hr LED-2X9W	2x9W	1800 Lm	IP65	280mm	73mm	300mm

## ILLUSTRATION

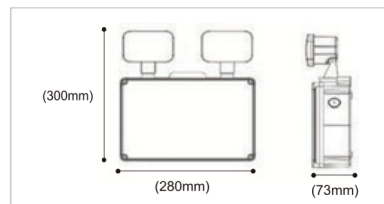

## OPTIONS:

-  Dimmable Driver 1 -10 / DALI  Backup Emergency Kit 1H/3H



OUTDOOR

# ROAD LIGHT

**APPLICATIONS:**

Street lighting, urban area lighting , etc.

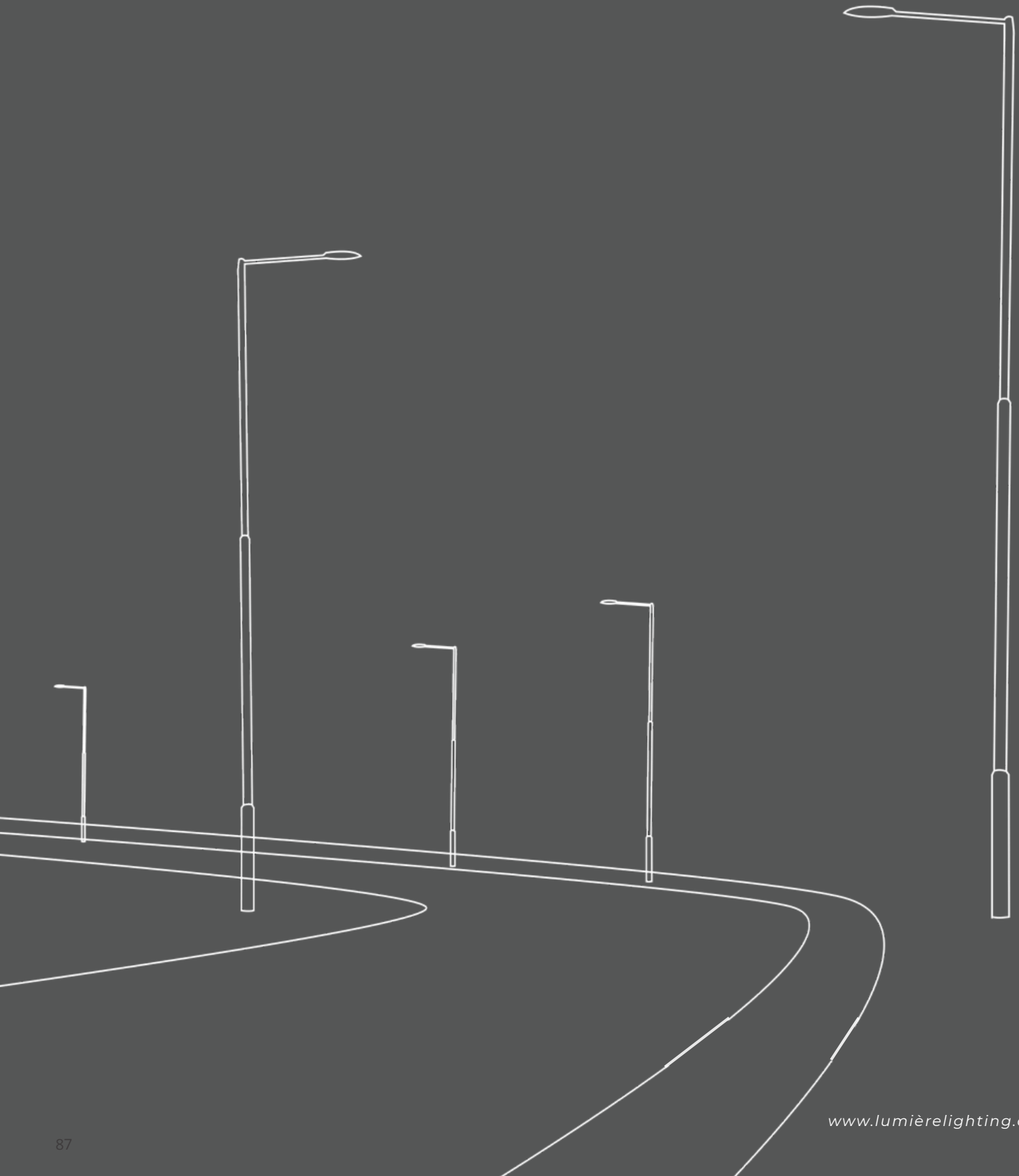





# VEGA IP66

## APPLICATIONS:

Suitable to be used in : Street lighting, urban area lighting .

## التطبيقات

مناسبة للاستخدام في : إنارة الشوارع و المناطق الحضرية .

### General Specifications:

	Pole Mounting
	Die casted aluminium
	IP66
	60,000 Hrs ( L70 @ 55C° )
	-20 : 55°C
	5 Years

### Optical Data:

	High Quality LED Chip
	SMD
	130 lm/W
	60°*40°*120/140°*80/90°/45°/30°
	3000K/6500K
	> 80

### Electrical Data:

	25-70W/80-160W/180-315W
	Constant current LED driver
	(120-277) Vac
	50-60 Hz
	> 0.95



## DESCRIPTIONS:

VEGA series is a professional LED street lighting solution designed to maintain high performance in most severe weather Conditions (50°C, 90% RH) using high quality Die cast aluminum housing of IP66 rating, IK08. VEGA series has the ability to use medium power LEDs or high power LEDs. Fully customized using properly calculated Modular design to cover different requirements from 30W up to 350W and 3,900 Lumen to 45,500 system output lumen.

## الوصف

VEGA IP66 هي عبارة عن حل إضاءة احترافية ليد للشوارع مصمم للحفاظ على الأداء العالي في أكثر الظروف الجوية قسوة (50 درجة مئوية ، 90% رطوبة نسبية) باستخدام جسم عالي الجودة مصنوع من الألومنيوم المصبوب بتقني سلسلة لديها القدرة على إستخدام ليدات متوسطة الطاقة أو ليدات عالية الطاقة مخصصة بالكامل باستخدام تصميم وحدات محسوب بشكل صحيح لتغطية الاحتياجات المختلفة من 30 واط حتى 350 واط و من 3900 لومين إلى 45500 لومين

## SPECIFICATIONS:

Model	Wattage	Lumen	Driver Type	L	W	H
VEGA HP MINI	25-70W	3900-9,100 Lm	Constant Current LED Driver	617mm	280mm	120mm
VEGA HP MIDI	80-160W	10,400-20,800 Lm	Constant Current LED Driver	677mm	280mm	120mm
VEGA HP GRANDE	180-315W	23,400-45,500 Lm	Constant Current LED Driver	920mm	280mm	120mm

### SIZE | LED-VEGA MINI 25-70W

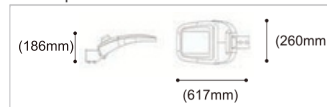

### SIZE | LED-VEGA MIDI 80-160W

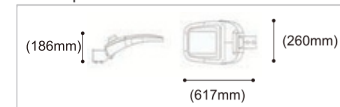

### SIZE | LED-VEGA GRANDE 180-315W

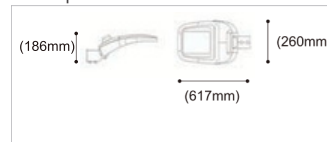

### LIGHT DISTRIBUTION

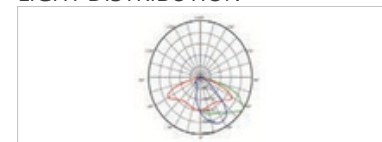

## OPTIONS:

- + Dimmable Driver 1-10 / DALI





# MOON IP66

## APPLICATIONS:

Suitable to be used in : Street lighting, urban area lighting .

## التطبيقات

مناسبة للاستخدام في : إنارة الشوارع و المناطق الحضرية .





## General Specifications:

 Mounted	Pole Mounting
 Material	Die casted aluminium
 IP	IP66
 Lifetime	50,000 Hrs ( L70 @ 55°C )
 Temperature	-20 : 55°C
 Warranty	5 Years

## Optical Data:

 chips	High Quality LED Chip
 COB SMD	SMD
 Lm	130-140 lm/W
 beam angle	60°*40°*120/140°*80/90°/45°/30°
 CCT	2200K/2700K/3000K/4000K 5700K/6000K
 CRI	> 70

## Electrical Data:

 LED Wattage	40-500W
 driver	Constant current LED driver
 Voltage	(120-277) Vac
 HZ	50-60 Hz
 PF	> 0.95

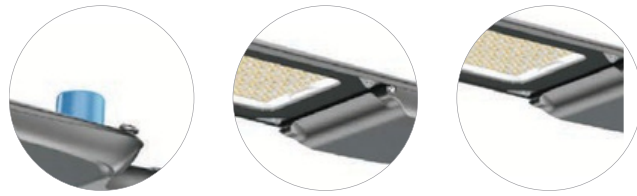

## DESCRIPTIONS:

MOON IP66 series is a professional LED street lighting solution designed to maintain high performance in most severe weather conditions (50°C, 90% RH) using high quality Die cast aluminum housing of IP66 rating, IK08 & that can to withstand wind speed up to 160 Km/hr which provide strong performance & different working environment.

MOON has the ability to use medium power LEDs or high power LEDs. Fully customized using properly calculated Modular design to cover different requirements from 30W up to 500W and 4,200 Lumen to 70,000 system output lumen.

**الوصف**  
MOON IP66 عبارة عن حل احترافي لإضاءة الشوارع مصمم للحفاظ على الأداء العالي في أقسى الظروف الجوية (50 درجة مئوية، 90% رطوبة نسبية) باستخدام هيكل من الألومنيوم المصبوب عالي الجودة بتصنيف IP66 و IK08 ويمكنه تحمل سرعة الرياح حتى 160 كم/ساعة مما يوفر أداءً قوياً وبيئة عمل مختلفة.

بشكلاً مصمماً بشكل صحيح لتغطية المتطلبات المختلفة من 30 واط إلى 500 واط و 4,200 لومن إلى 70,000 لومن .

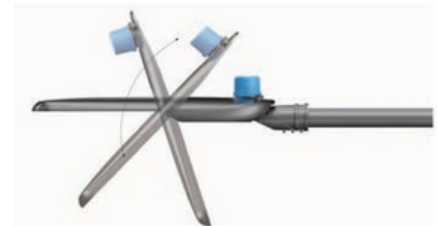
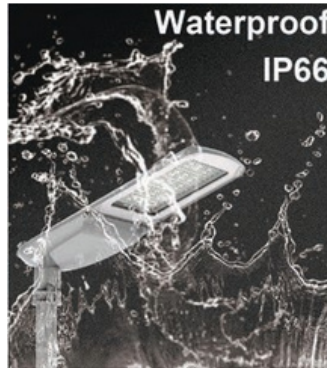

Cover Opening design

Rotary snap + cover opening design, no tools are needed for snap closing. The lamp cover can be opened and closed with large diameter at any angle, and it is easy to install, maintain and operate without restriction

## OPTIONS:

-  + Dimmable Driver 1 -10 / DALI



OUTDOOR

# TUNNEL LIGHT

**APPLICATIONS:**

Court , Golf Course , Large Parking Lot , Airport ,  
Wharf , Construction Site.

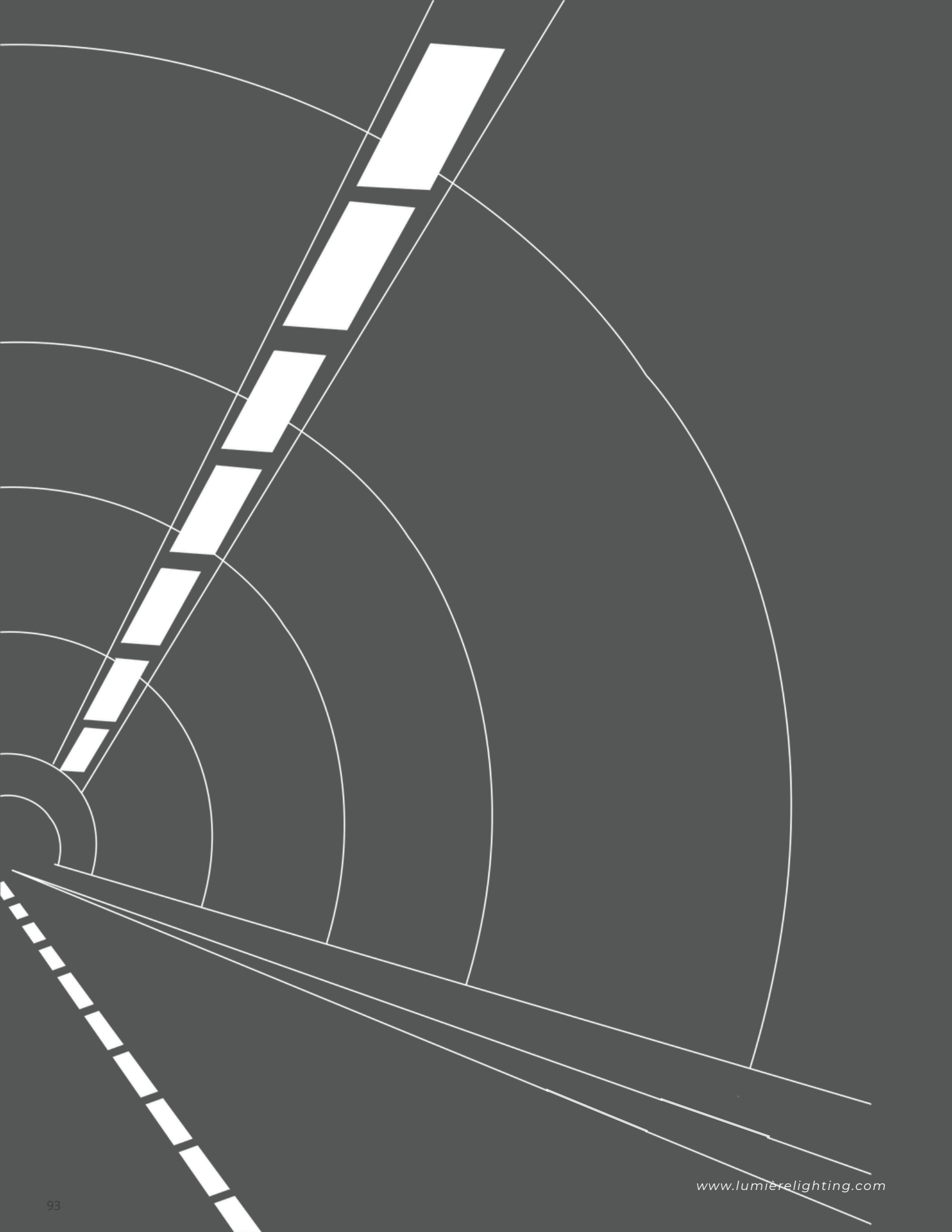





# TL01 IP66

## APPLICATIONS:

Suitable to be used in : Court , Golf Course , Large Parking Lot , Airport , Wharf , Construction Site and Tunnels

التطبيقات  
مناسبة للاستخدام في : الملاعب ، ملاعب الجولف ، مواقف السيارات الكبيرة ، المطارات ،  
الأرصفة ، مواقع البناء ، والأنفاق

## General Specifications:

Mounted	Ceiling mounted
Material	Die casted aluminium
IP	IP66
	60,000 Hrs ( L70 @ 55C° )
	-20 : 55°C
warranty	5 Years

## Optical Data:

chips	High Quality LED Chip
COB SMD	SMD
Lm	120 lm/W
beam angle	60°*40°*120/140°*80/90°/45°/30°
CCT	3000K/6500K
CRI	> 80

## Electrical Data:

LED Wattage	100W/150W
driver	Constant current LED driver
Voltage	(100-277) Vac
HZ	50-60 Hz
PF	> 0.95

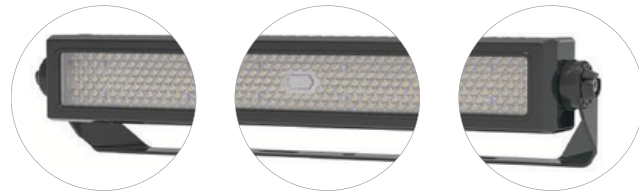

## DESCRIPTIONS:

LED - TNL01X IP66 with LED technique is the standard solution for outdoor tunnel areas, light spot. It is equipped with high quality electronic driver with protection against sand & water IP66 as per saudi & international standards. The housing Is die-cast aluminum with high quality electrostatic painting .

الوصف  
TNL01 IP66 هي وحدة إنارة أنفاق وهي الحل الأمثل لجميع أماكن الأنفاق ، الوحدة مزودة  
بمحول تشغيل إلكتروني ذو جودة عالية حسب المواصفات القياسية السعودية والدولية ودرجة حماية ضد  
الأتربة والماء ، الجسم مصنع من الألمنيوم المسبوك و المطلي بدهان إلكتروستاتيكي عالي الجودة.

## SPECIFICATIONS:

Model	Wattage	Lumen	Driver Type	Color Temperature	W	H
LED - NTL011 - 100W	100W	12,000 Lm	Constant Current LED Driver	3000K/6500K	140mm	150mm
LED - NTL012 - 150W	150W	18,000 Lm	Constant Current LED Driver	3000K/6500K	140mm	150mm

## ILLUSTRATION

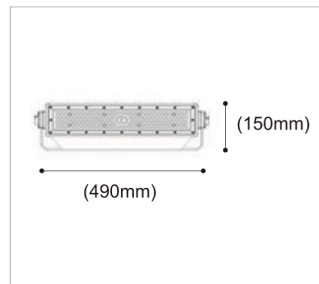

## LIGHT DISTRIBUTION

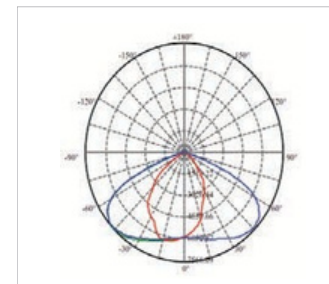

## OPTIONS:

- Dimmable Driver 1-10 / DALI

OUTDOOR

# AREA - FLOOD LIGHT

**APPLICATIONS:**

For commercial buildings, hospitals, yards, parks and walkways.

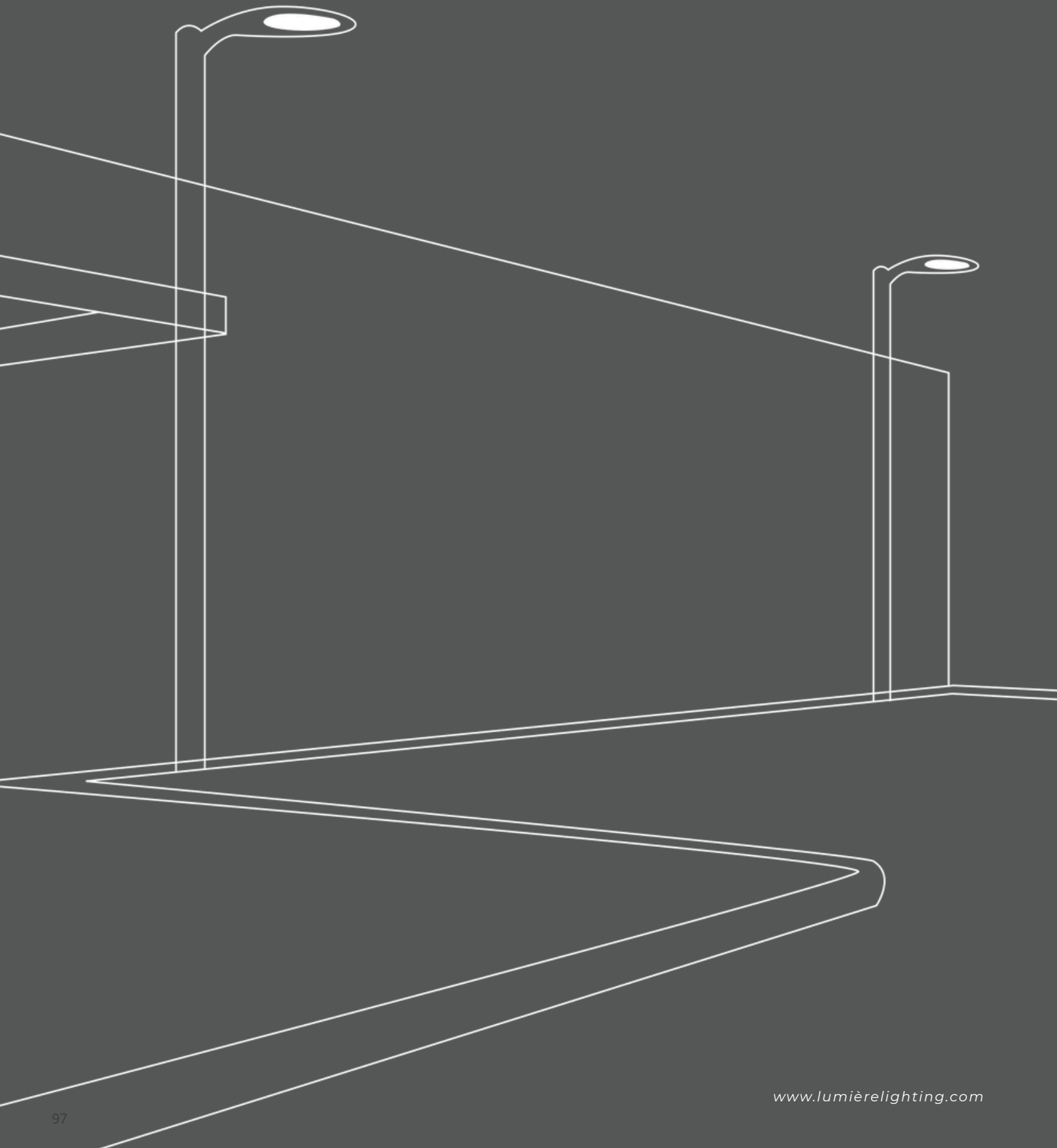





# LED - FLD ECO IP66

## APPLICATIONS:

Suitable to be used in : For commercial buildings, hospitals, yards, parks and walkways.

## التطبيقات

مناسبة للاستخدام في : المباني التجارية والمستشفيات والساحات والحدائق والممرات.



## DESCRIPTIONS:

ECO LED FLOOD LIGHT IP66 with LED technique is the standard solution for outdoor open areas, light spot. It is equipped with high quality electronic driver with protection against sand & water IP66 as per saudi & international standards. The housing is cold forge aluminum with high quality black electrostatic painting

## الوصف

معيارية للإضاءة في المناطق الخارجية والمساحات المفتوحة LED بتقنية IP66 معيارية للمعايير السعودية IP66 وهي مجهزة بمحول إلكتروني عالي الجودة مع حماية ضد الرمال والماء بمعايير والدولية. الهيكل مصنوع من الألومنيوم المبرد عالي الجودة مع طلاء أسود كهروستاتيكي عالي الجودة.

## General Specifications:

 Mounted	Handle Mounting
Material	Die casted aluminum
IP	IP66
	50,000 Hrs ( Ta=30°C@L70 )
	-30 : 40°C
	5 Years

## Optical Data:

chips	High Quality LED Chip
COB SMD	SMD
Lm	130-150 lm/W
beam angle	120°
CCT	3000-6500K
CRI	> 85

## Electrical Data:

LED Wattage	50W/100W/150W/200W
driver	Integrated Electronic LED
Voltage	(100-277) Vac
HZ	50-60 Hz
PF	> 0.95

## SPECIFICATIONS:

Model	Wattage	Lumen	Driver Type	L	W	H
ECO. 50W	50W	7,500 lm	Constant Current LED Driver	281mm	212mm	45mm
ECO. 100W	100W	15,000 lm	Constant Current LED Driver	356mm	252mm	50mm
ECO. 150W	150W	22,500 lm	Constant Current LED Driver	400mm	322mm	53mm
ECO. 200W	200W	30,000 lm	Constant Current LED Driver	457mm	361mm	54mm

## ILLUSTRATION

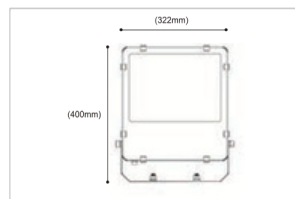

## LIGHT DISTRIBUTION

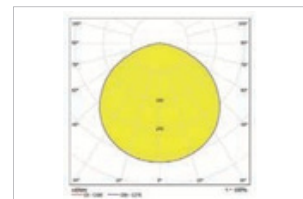

## OPTIONS:

–  Dimmable Driver 1 -10 / DALI

Available Color Temperatures : 3000K , 4000K , 5700K , 6500K

**ECO. LED FLOOD LIGHT 50W**



**ECO. LED FLOOD LIGHT 100W**

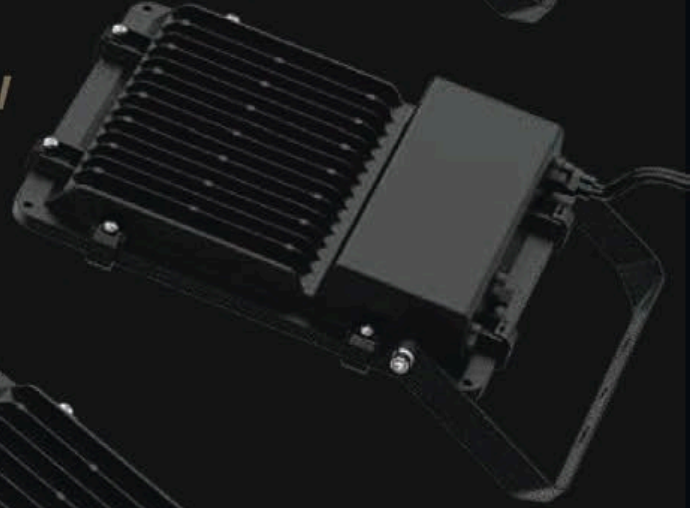

**ECO. LED FLOOD LIGHT 150W**



**ECO. LED FLOOD LIGHT 200W**

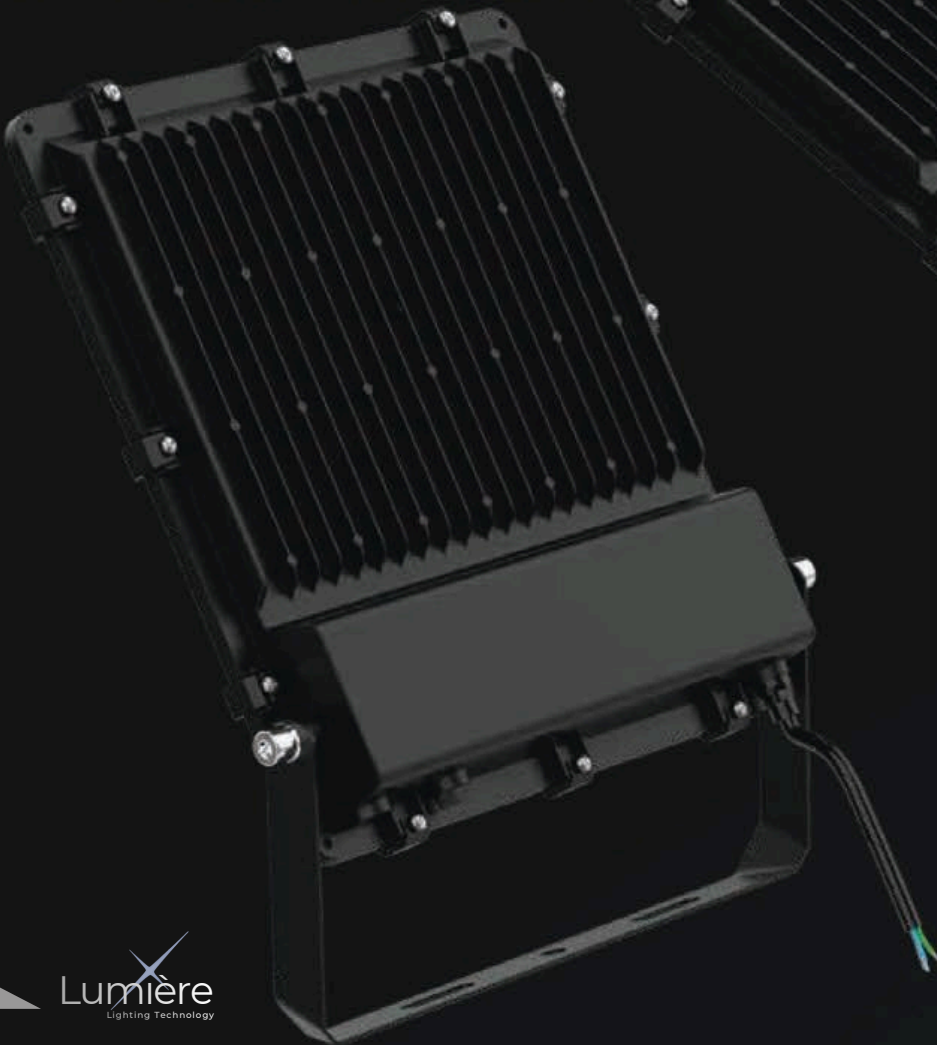

**There are two kinds of lenses for our new floodlight,  
Glass lens and PC+Glass lens.**



**Luminous Efficiency  
up to 150lm/W, Ra70**



**High power floodlights  
up to 200W**

**Lifetime ,the lifespan  
is 50,000 hours**

**Adjustable bracket, easily set  
the luminaire in right angles**





# FLD07 IP66

## APPLICATIONS:

Suitable to be used in : Airport Lighting , Expressway & Freeway Interchanges , Port Facilities , Trailer / Container yard & Rail yard operations .

التطبيقات مناسبة للاستخدام في : إنارة المطار ، تقاطعات الطرق السريعة والطرق السريعة ، مرافق الموانئ ، ساحة المقطورة / الحاويات وعمليات ساحة السكك الحديدية .

## General Specifications:

Mounted	Handle Mounting
Material	Cold forge aluminum
IP	IP66
	50,000 Hrs ( L70 @ 55C° )
	-40 : 50°C
warranty	5 Years

## Optical Data:

chips	High Quality LED Chip
COB SMD	SMD
Lm	145 lm/W
beam angle	10°/25°/45°/60°/90°
CCT	3000K : 6500K
CRI	> 70 & 80 & 90

## Electrical Data:

LED Wattage	10W/20W/30W
driver	Integrated Electronic LED
Voltage	(100-277) Vac
HZ	50-60 Hz
PF	> 0.95



FLD07 IP66 Family has the following features :

\* PMMA adopts matrix full light cutting design. By adding a concave light retaining wall, excess light can be removed and the effect of receiving & blocking can be achieved.

The design scheme can meet users' requirements for light seeing range to a greater extent.

\* The overall streamline of the lamp body is beautiful, generous and decent.

The back adopts

fin type heat dissipation structure, with better heat dissipation effect. Edge sinking design and

convection vents, optimize air convection quality, strengthen heat dissipation, fully ensure the life of the lamp

الوصف

إن عائلة FLD07X IP66 LED - تتميز بالميزات التالية:

\* تعتمد PMMA تصميم قطع مصفوفة بضوء كامل. عن طريق إضافة ضوء مقعر الاحتفاظ الجدار ،

يمكن إزالة الضوء

الزائد ويمكن أن يكون تأثير الاستلام والحظر تحقق. يمكن أن يلبى مخطط التصميم متطلبات

المستخدمين لرؤية

الضوء إلى حد أكبر.

\* التصميم العام لهيكل المصباح جميل وسخي ولائق. يعتمد الجزء الخلفي على هيكل تبديد الحرارة

من نوع الزعنفة ،

مع تأثير تبديد حرارة أفضل. تصميم غرق الحواف وفتحات الحمل الحراري ، وتحسين جودة الهواء

الحراري ،

تعزيز تبديد الحرارة ، ضمان كامل عمر المصباح

## OPTIONS:

- ☺+ Dimmable Driver 1 -10 / DALI

Available Color Temperatures : 3000K , 4000K , 5700K , 6500K

SPECIFICATIONS:

Model	Wattage	Lumen	Light Source	Driver Type	L	W	H
FLD071 IP66	230W	33,350 Lm	LUMILEDS SMD5050 Chips	Constant Current LED Driver	664mm	468mm	224mm
FLD072 IP66	315W	43,470 Lm	LUMILEDS SMD5050 Chips	Constant Current LED Driver	664mm	468mm	224mm
FLD073 IP66	380W	51,300 Lm	LUMILEDS SMD5050 Chips	Constant Current LED Driver	664mm	468mm	224mm
FLD074 IP66	460W	65,780 Lm	LUMILEDS SMD5050 Chips	Constant Current LED Driver	705mm	550mm	218mm
FLD075 IP66	580W	80,040 Lm	LUMILEDS SMD5050 Chips	Constant Current LED Driver	705mm	550mm	218mm
FLD076 IP66	720W	95,040 Lm	LUMILEDS SMD5050 Chips	Constant Current LED Driver	705mm	550mm	218mm

SIZE | LED-FLD071 230W

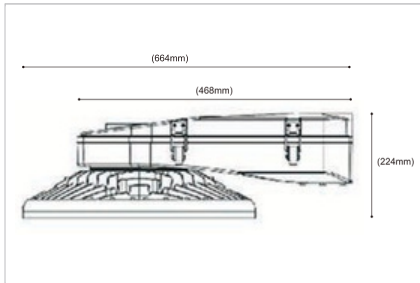

SIZE | LED-FLD072 315W

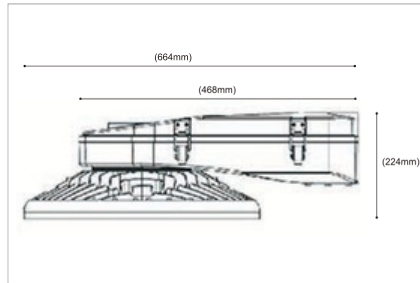

SIZE | LED-FLD073 380W

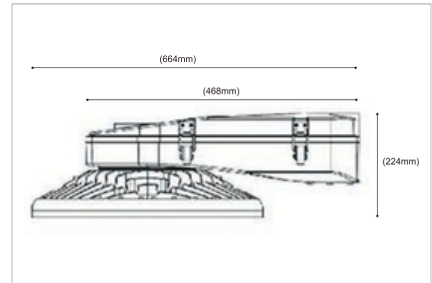

SIZE | LED-FLD074 460W

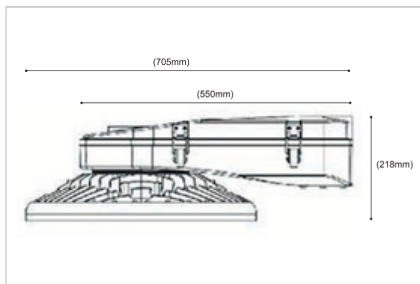

SIZE | LED-FLD075 580W

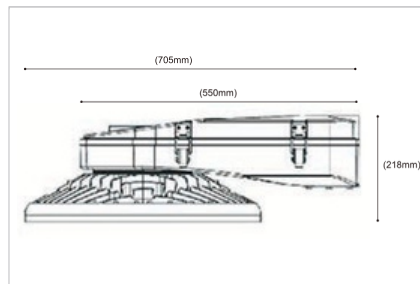

SIZE | LED-FLD076 720W

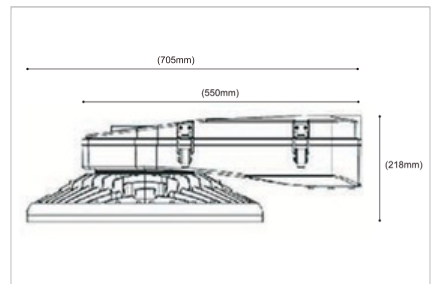

LIGHT DISTRIBUTION

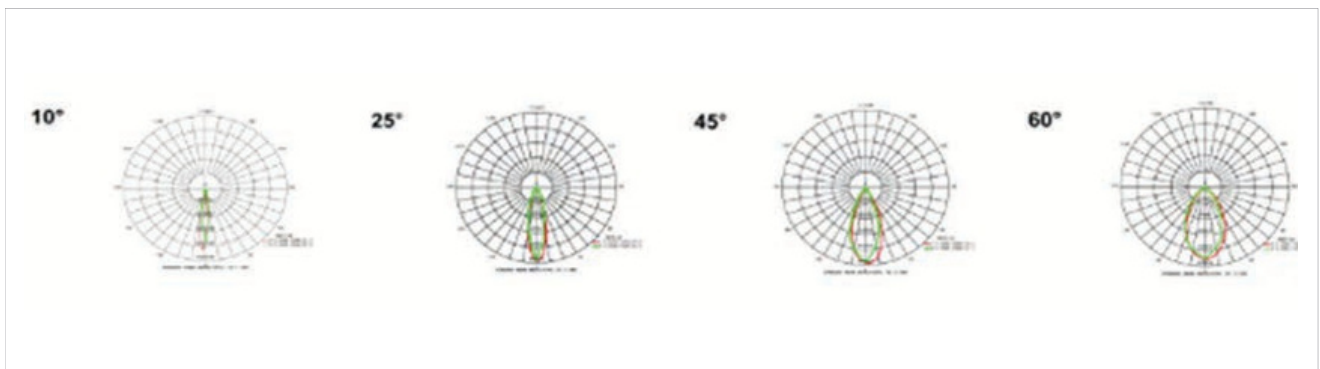



For easy wiring  
& installation

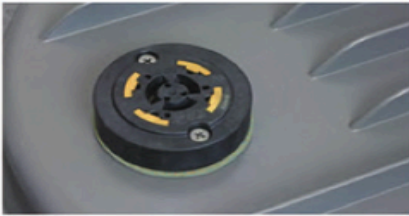

3 or 7-pin receptacle  
with a variety of  
controls options



Bolt mounting  
3G rating



A stylized white line drawing on a dark grey background depicts a stadium's lighting system. Two clusters of oval-shaped lights are positioned on the upper tiers of the stadium, and a larger cluster of circular lights is located on the lower tier. The stadium's structure is represented by a series of parallel lines that converge towards the top, creating a sense of depth and perspective.

OUTDOOR

# SPORT LIGHT

**APPLICATIONS:**

Lighting of stadiums, rest houses and camps .

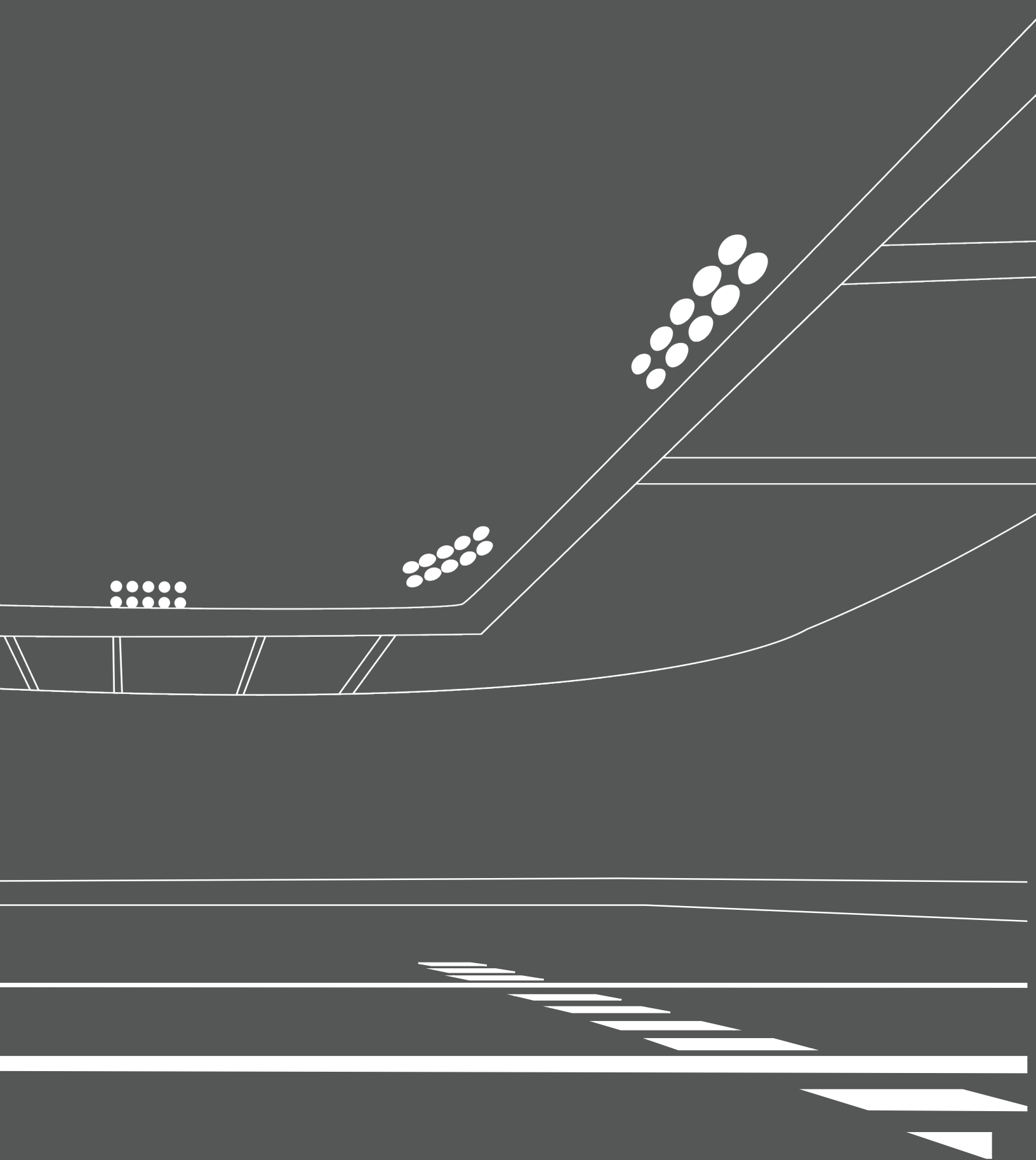





# FLD06 IP66

## APPLICATIONS:

Suitable to be used in : Lighting of stadiums, rest houses and camps .

## التطبيقات

مناسبة للاستخدام في : إنارة الملاعب و الإستراحات و المخيمات .

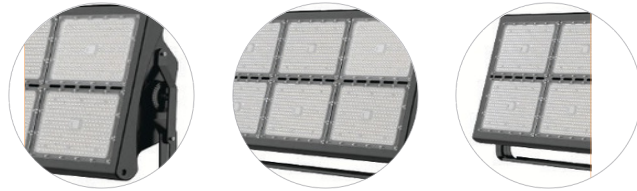

## General Specifications:

Mounted	Handle Mounting
Material	Cold forge aluminum
IP	IP66
	50,000 Hrs ( L70 @ 50C° )
	-30 : 50°C
warranty	5 Years

## Optical Data:

chips	High Quality LED Chip
COB SMD	SMD
Lm	130 lm/W
beam angle	10°/25°/45°/60°/90°
CCT	3000K/4000K/6500K
CRI	> 85

## Electrical Data:

LED Wattage	(400-1500)W
driver	Integrated Electronic LED
Voltage	(220-240) Vac
HZ	50-60 Hz
PF	> 0.95

## DESCRIPTIONS:

LED - FLD06X IP66 with LED technique is the standard solution for outdoor open areas, light spot. It is equipped with high quality electronic driver with protection against sand & water IP66 as per saudi & international standards. The housing Is cold forge aluminum with high quality black electrostatic painting .

## الوصف

FLD06 IP66 هي وحدة الإنارة الموجهة الخارجية بتقنية LED وهي الحل الأمثل للأماكن المفتوحة الخارجية وتسلط الضوء ، الوحدة مزودة بمحول تشغيل إلكتروني ذو جودة عالية حسب المواصفات القياسية السعودية والدولية ودرجة حماية ضد الأتربة والماء IP 66 والجسم مصنع من الألمنيوم المسحوب على البارد و المطلى بدهان إلكتروستاتيكي أسود عالي الجودة .

## OPTIONS:

- ☺+ Dimmable Driver 1 -10 / DALI

Available Color Temperatures : 3000K , 4000K , 5700K , 6500K

SPECIFICATIONS:

Model	Wattage	Lumen	Driver Type	L	W	H
FLD061	400W	52,000 Lm	Constant Current LED Driver	471mm	325mm	141mm
FLD062	500W	65,000 Lm	Constant Current LED Driver	471mm	325mm	141mm
FLD063	800W	104,000 Lm	Constant Current LED Driver	536mm	629mm	160mm
FLD064	1000W	130,000 Lm	Constant Current LED Driver	536mm	629mm	160mm
FLD065	1200W	165,000 Lm	Constant Current LED Driver	536mm	889mm	160mm
FLD066	1500W	195,000 Lm	Constant Current LED Driver	536mm	889mm	160mm

SIZE | LED-FLD061 400W

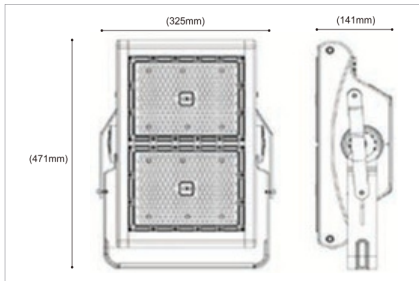

SIZE | LED-FLD062 500W

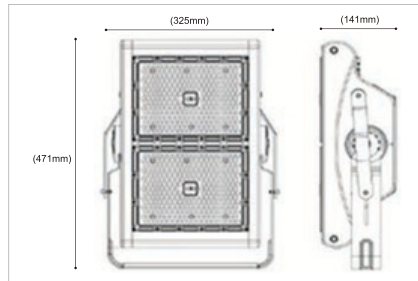

SIZE | LED-FLD063 800W

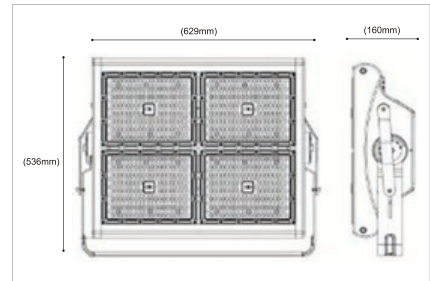

SIZE | LED-FLD064 1000W

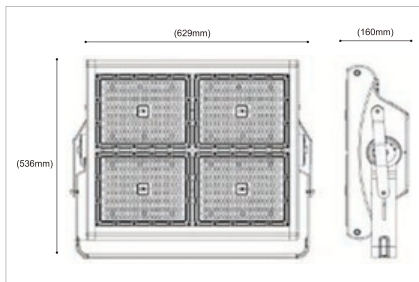

SIZE | LED-FLD065 1200W

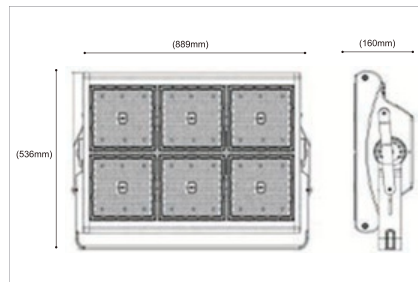

SIZE | LED-FLD066 1500W

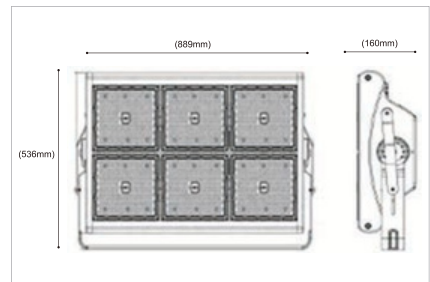



Vertical Mounting



Wall Mounting

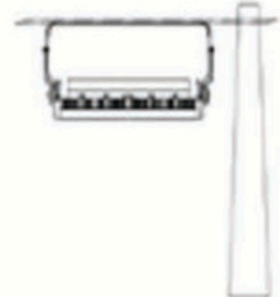

Hanging Mounting

LIGHT DISTRIBUTION

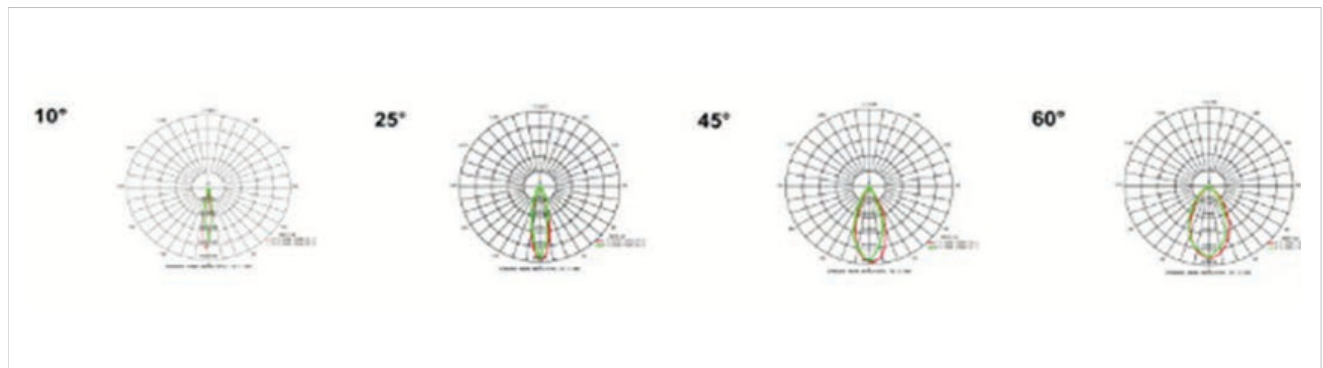





# FLD08 IP66

## APPLICATIONS:

Suitable to be used in : Sports Lighting, Stadium lighting, Sports fields, Car parks, High mast installations Dock, railway and container yards, Ports and other large scale outdoor applications, Architectural lighting, Landscape lighting, Industrial and commercial exterior lighting Decorative lighting for holidays, tradeshow, exhibitions.

**التطبيقات**  
مناسبة للاستخدام في : الإضاءة الرياضية ، وإضاءة الملاعب ، والملاعب الرياضية ، ومواقف السيارات ، وتركيبات الصاري العالية ، حوض السفن ، وساحات السكك الحديدية والحاويات ، والموانئ والتطبيقات الخارجية واسعة النطاق الأخرى ، والإضاءة المعمارية ، وإضاءة المناظر الطبيعية ، والإضاءة الخارجية الصناعية والتجارية ، والإضاءة الزخرفية لقضاء العطلات ، والمعارض التجارية ، والمعارض.

## General Specifications:

	Handle Mounting
	Cold forge aluminum
	IP66
	50,000 Hrs ( L70 @ 55C° )
	-40 : 50°C
	5 Years

## Optical Data:

	High Quality LED Chip
	SMD
	120 lm/W & 150 lm/W
	10°/15°/30°/60°/90°/ T2
	3000K/6500K
	> 85

## Electrical Data:

	(400 : 1800) W
	Integrated Electronic LED
	(100-277) Vac
	50-60 Hz
	> 0.95



## DESCRIPTIONS:

LED-FLD08XIP66withLEDtechniqueisthestandard solution for outdoor open areas, light spot. It is equipped with high quality electronic driver with protection against sand & water IP66 as per Saudi & international standards. The housing is cold forge aluminum with high quality black electrostatic painting .

## الوصف

LED FLD08X IP66 هي وحدة الإنارة الموجهة الخارجية بتقنية LED وهي الحل الأمثل للأماكن المفتوحة الخارجية وتسلط الضوء ، الوحدة مزودة بمحول تشغيل إلكتروني ذو جودة عالية حسب المواصفات القياسية السعودية والدولية ودرجة حماية ضد الأتربة والماء IP66 الجسم مصنع من الألومنيوم المسحوب على البارد و المطلي بدهان إلكتروستاتيكي أسود عالي الجودة .

## OPTIONS:

- Dimmable Driver 1 -10 / DALI

Available Color Temperatures : 3000K , 4000K , 5700K , 6500K

SPECIFICATIONS:

Model	Wattage	Lumen	Light Source	Driver Type	Beam Angle
FLD081-400W	400W	120-150 Lm	SAMSUNG 3535 SMD 5050	Constant Current LED Driver	10°/15°/30°/60°/90°/ T2
FLD082-500W	500W	120-150 Lm	SAMSUNG 3535 SMD 5050	Constant Current LED Driver	10°/15°/30°/60°/90°/ T2
FLD083-600W	600W	120-150 Lm	SAMSUNG 3535 SMD 5050	Constant Current LED Driver	10°/15°/30°/60°/90°/ T2
FLD084-800W	800W	120-150 Lm	SAMSUNG 3535 SMD 5050	Constant Current LED Driver	10°/15°/30°/60°/90°/ T2
FLD085-1000W	1000W	120-150 Lm	SAMSUNG 3535 SMD 5050	Constant Current LED Driver	10°/15°/30°/60°/90°/ T2
FLD086-1200W	1200W	120-150 Lm	SAMSUNG 3535 SMD 5050	Constant Current LED Driver	10°/15°/30°/60°/90°/ T2
FLD087-1500W	1500W	120-150 Lm	SAMSUNG 3535 SMD 5050	Constant Current LED Driver	10°/15°/30°/60°/90°/ T2
FLD088-1800W	1800W	120-150 Lm	SAMSUNG 3535 SMD 5050	Constant Current LED Driver	10°/15°/30°/60°/90°/ T2

SIZE | LED-FLD081 400W

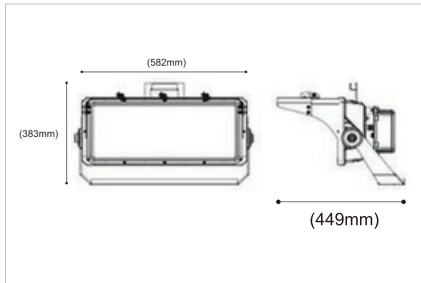

SIZE | LED-FLD082 500W

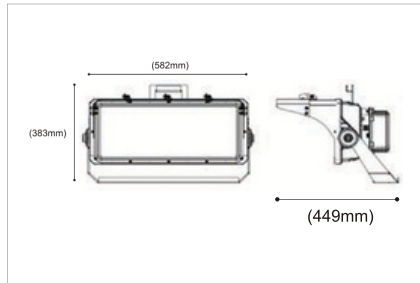

SIZE | LED-FLD083 600W

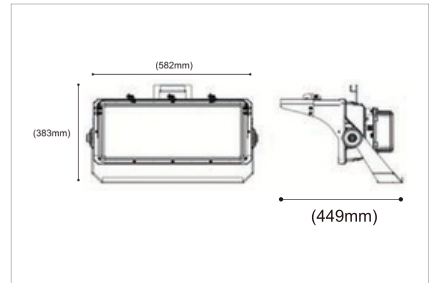

SIZE | LED-FLD084 800W

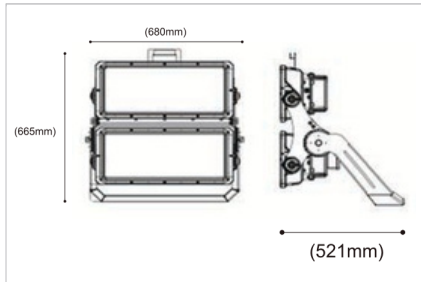

SIZE | LED-FLD085 1000W

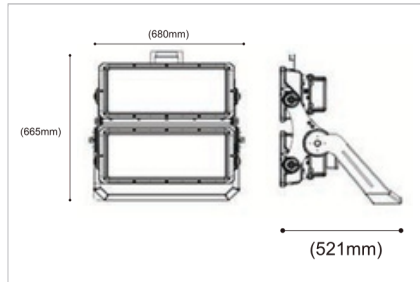

SIZE | LED-FLD086 1200W

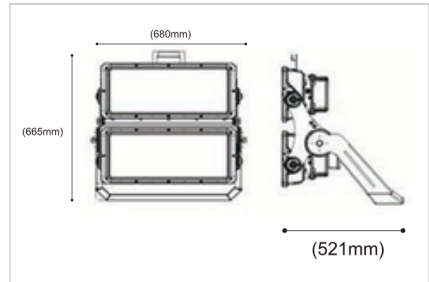

SIZE | LED-FLD087 1500W

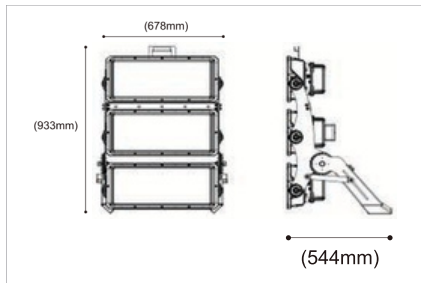

SIZE | LED-FLD088 1800W

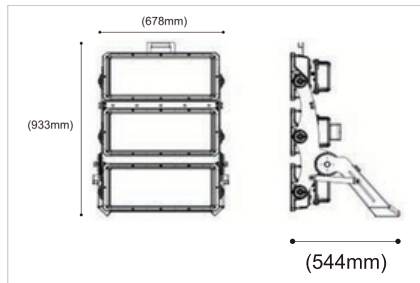

LIGHT DISTRIBUTION

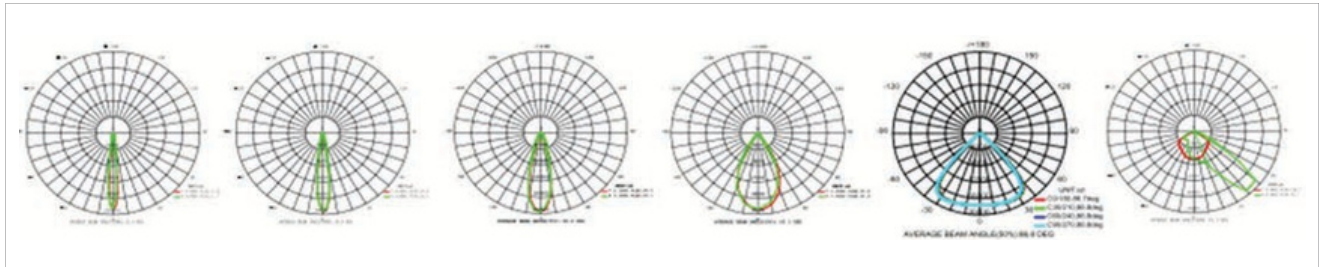

## Model Options



P1

400W/500W/600W

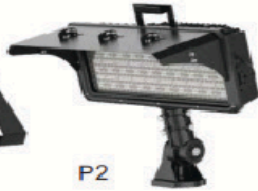

P2



P1

800W/1000W/1200W



P1

1500W/1800W

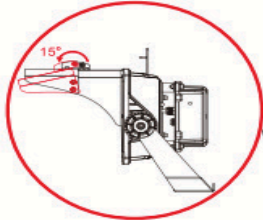

Anti glare Lighting cover  
Freely Adjustable 15°

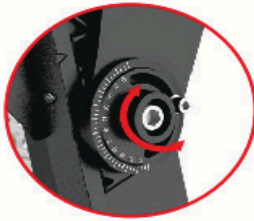

The rotation of a single module  
can be achieved by adjusting the  
screw on **only** one side

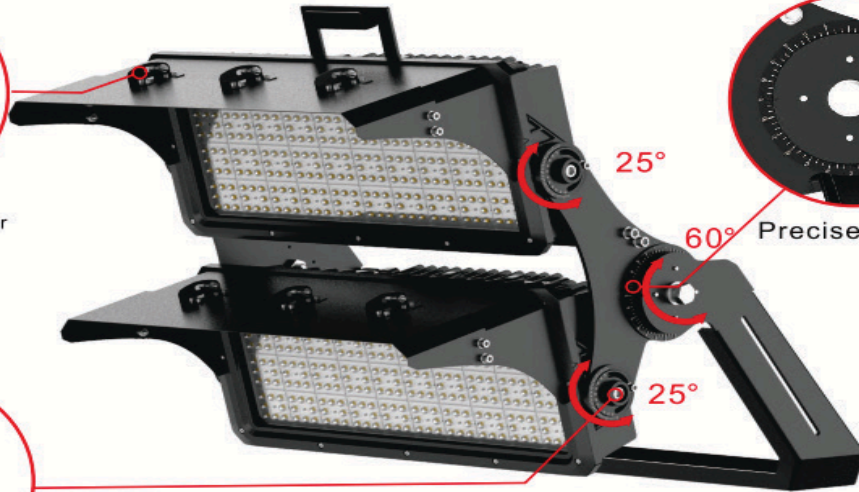

25°

60°

25°

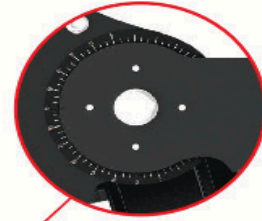

Precise adjustment

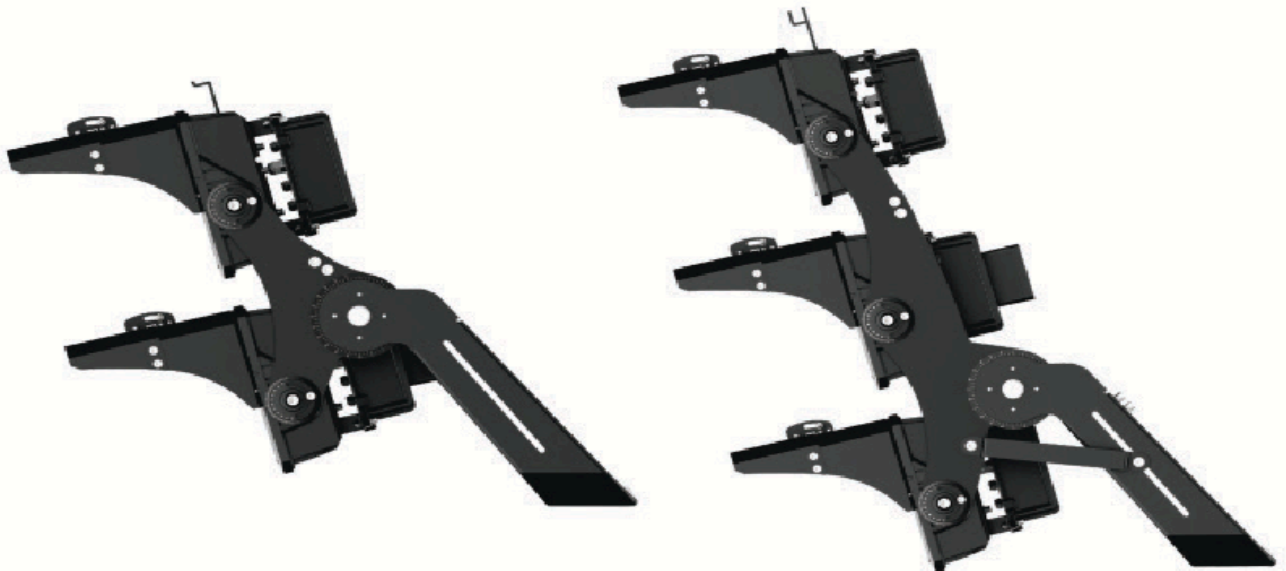



# HIGH BAY

## APPLICATIONS:

Factories and hangers

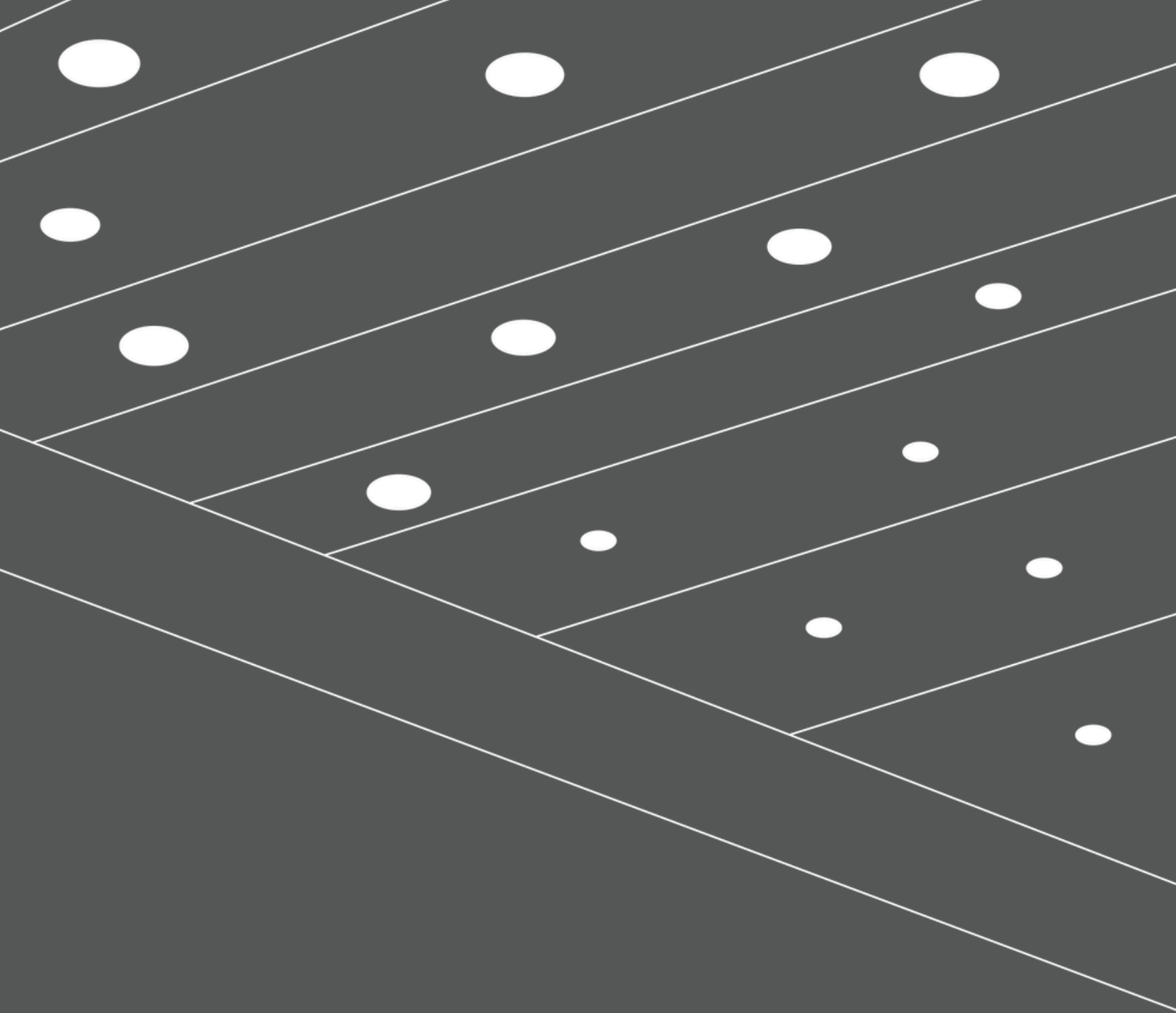





# LED - HIGH BAY IP65

## APPLICATIONS:

Suitable to be used in : Factories, Warehouses & Hangars .

## التطبيقات

مناسبة للاستخدام في : المصانع والمستودعات والهاجر.





## General Specifications:

 Mounted	Suspended Mounting
 Material	High quality die cast aluminum
 IP	IP65
 50,000 Hrs ( L70 @ 50C° )	50,000 Hrs ( L70 @ 50C° )
 -30 : 50°C	-30 : 50°C
 warranty	5 Years

## Optical Data:

 chips	High Quality LED Chip
 COB SMD	SMD
 Lm	140/170/190 lm/W
 beam angle	60°/90°/120°
 CCT	3000K/4000K/6500K
 CRI	> 80

## Electrical Data:

 LED Wattage	100W/150W/240W
 driver	Constant current LED driver
 Voltage	(220-240) Vac
 HZ	50-60 Hz
 PF	> 0.95



## DESCRIPTIONS:

HIGH BAY IP65 is LED UFO High Bay Lights are energy-efficient lights that produce a large lumen output on small power input. These lights distribute lights uniformly over a large area like a warehouse. These lights are better than the traditional lights in terms of energy efficiency and cost-effectiveness.

## الوصف

هي وحدة انارة عالية الطاقة كما انها موفرة للطاقة بقيم لومين كبيرة على مدخلات طاقة صغيرة ، توزع هذه الوحدات الإنارة بشكل موحد على مساحة كبيرة مثل المستودعات ، وحدات الإنارة هذه افضل من المصابيح التقليدية من حيث كفاءة الطاقة وفعالية التكلفة

## SPECIFICATIONS:

Model	Wattage	Lumen	Driver Type	Beam Angle	Ø	H
I-BAY-(30-90)W	(30-90)W	(3,900-11,700) Lm	Constant Current LED Driver	60° , 90° , 120°	290mm	130mm
I-BAY-(100-150)W	(100-150)W	(13,000-19,500) Lm	Constant Current LED Driver	60° , 90° , 120°	340mm	140mm
I-BAY-(180-240)W	(180-240)W	(23,400-31,200) Lm	Constant Current LED Driver	60° , 90° , 120°	386mm	155mm

## ILLUSTRATION

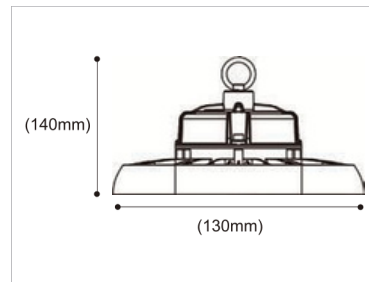

## LIGHT DISTRIBUTION

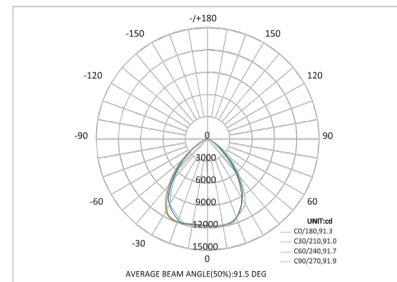

## OPTIONS:

-  Dimmable Driver 1-10 / DALI

OUTDOOR

# WALL LIGHT

**APPLICATIONS:**

building exteriors, courtyard and other similar outdoor applications .









# WL08 IP66

## APPLICATIONS:

Suitable to be used in : building exteriors, courtyard and other similar outdoor applications .

## التطبيقات

مناسبة للاستخدام في : الجدار والسلالم والتطبيقات الخارجية المماثلة الأخرى .





## General Specifications:

 Mounted	Wall
 Material	Die casted aluminium
 IP	IP66
	50,000 Hrs ( L70 @ 25C° )
	-30 : 50°C
 warranty	5 Years

## Optical Data:

 chips	High Quality LED Chip
 COB SMD	SMD
 Lm	140 lm/W
 beam angle	U00C04
 CCT	3000K/4000K/6500K
 CRI	> 80

## Electrical Data:

 LED Wattage	15W
 driver	Constant current LED driver
 Voltage	(220-240) Vac
 HZ	50-60 Hz
 PF	> 0.92

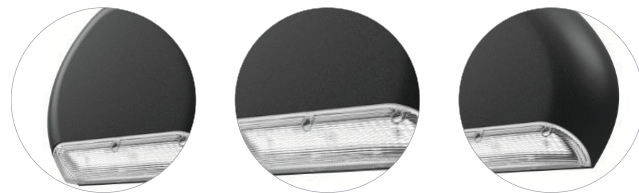

## DESCRIPTIONS:

WL08 - IP66 is a Slim and elegant design ensures a discreet integration without compromising on performance. Suited to various applications such as building exteriors, outdoor corridors, garages, paths and other outdoor environments, wall pack not only provides energy efficient lighting, it delivers a bright white light to ensure perfect visibility and comfort at all times .

## الوصف

WL08 IP66 هو تصميم نحيف وأنيق يضمن تكامل شامل دون التأثير على الأداء ، مناسبة لتطبيقات مختلفة مثل التصميمات الخارجية للمباني والممرات الخارجية والجراجات والمسارات والبيئات الخارجية الأخرى ، وحدة الإضاءة هذه ليست موفرة للطاقة فحسب ، بل توفر ضوءاً أبيض ساطعاً لضمان الرؤية المثالية والراحة في جميع الاوقات .

## SPECIFICATIONS:

Model	Wattage	Lumen	Driver Type	L	W	H
WL08 - 01	15W	2100 Lm	ConstantCurrent LED Driver	293mm	289mm	97mm

## ILLUSTRATION

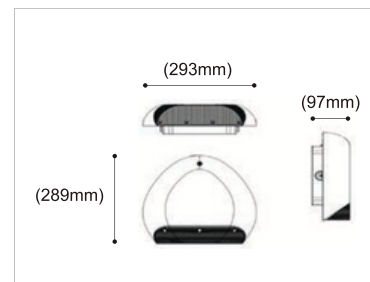

## LIGHT DISTRIBUTION

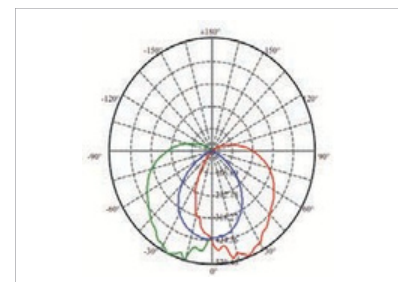

## OPTIONS:

-  Dimmable Driver 1 -10 / DALI

 Backup Emergency Kit 1/3Hr



# WL9 IP54

## APPLICATIONS:

Suitable to be used in : Wall lightig, building surrounding, electrical and mechanical rooms and other similar outdoor applications.

## التطبيقات

مناسبة للاستخدام في : إضاءة الحوائط والأبنية المحيطة والغرف الكهربائية والميكانيكية، وغيرها من التطبيقات الخارجية المماثلة.



## DESCRIPTIONS:

WL9 IP54 is a general purpose high quality LED bulkhead luminaire for outdoor applications. Using of high quality die cast aluminium housing and PC diffuser make this product suitable for the most severe conditions with protection degree IP 54.

## الوصف

WL9 IP54 هي عائلة متعددة الأغراض لإنارة عالية الجودة وتستخدم للتطبيقات في الهواء الطلق LED . إن استخدام الجسم الألمنيوم المصبوب عالي الجودة وناشر ثلجي ضد الصدمات مما يجعل هذا المنتج مناسباً لأقصى الظروف بدرجة حماية IP54 .





### General Specifications:

 Mounted	Wall
 Material	Die casted aluminium
 IP	IP54
 50,000 Hrs ( L70 @ 50C° )	
 -10 : 50°C	
 warranty	5 Years

### Optical Data:

 chips	High Quality LED Chip
 COB SMD	SMD
 Lm	60 lm/W
 beam angle	120°
 CCT	3000K/4000K/6500K
 CRI	> 80

### Electrical Data:

 LED Wattage	13W
 driver	Constant current LED driver
 Voltage	(220-240) Vac
 HZ	50-60 Hz
 PF	> 0.95

Model	Wattage	Lumen	Driver Type	L	W	H
LED-WL91-13W	13W	780 Lm	Constant Current LED Driver	129mm	242mm	149mm

### ILLUSTRATION

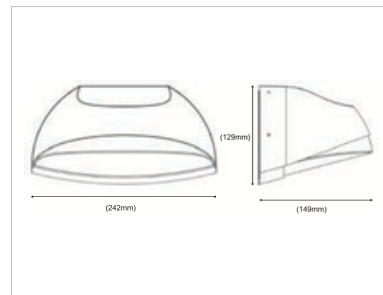

### LIGHT DISTRIBUTION

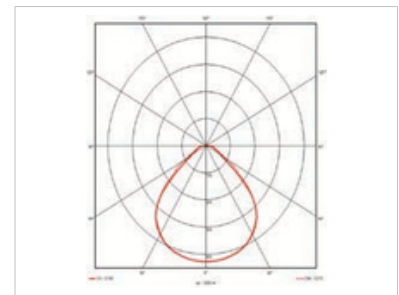

### OPTIONS:

–  + Dimmable Driver 1 -10 / DALI

 Backup Emergency Kit 1H/3H



# WDL05 IP65

## APPLICATIONS:

Suitable to be used in : Entrance, gates and other similar applications

## التطبيقات

مناسبة للاستخدام في : المداخل والبوابات والتطبيقات المشابهة الأخرى .



## DESCRIPTIONS:

WL05X LED Series is a general purpose high quality LED bulkhead decorative luminaire for Indoor applications. Using of high quality PC housing and Opal PC diffuser make this product suitable for the most severe conditions with protection degree IP65.

## الوصف

هي وحدة إضاءة ديكورية عالية الجودة للاستخدامات الداخلية. يتميز هذا المنتج WALLUX WL05X LED مما يجعله مناسباً لأقصى الظروف بفضل Opal PC، عالي الجودة وناشر ضوء PC بفضل استخدامه لغلاف درجة الحماية IP65.

## General Specifications:

Mounted	Wall
Material	Die casted aluminium
IP	IP65
	50,000 Hrs ( L70 @ 25C° )
	-10 : 40°C
warranty	5 Years

## Optical Data:

chips	High Quality LED Chip
COB SMD	SMD
Lm	90 lm/W
beam angle	120°
CCT	3000K/4000K/6500K
CRI	> 80

## Electrical Data:

LED Wattage	10W/20W/24W
driver	Constant current LED driver
Voltage	(220-240) Vac
HZ	50-60 Hz
PF	> 0.95

## SPECIFICATIONS:

Model	Wattage	Lumen	Driver Type	Beam Angle	Ø	H
WL051-10W	10W	900 Lm	Constant Current LED Driver	120°	220mm	65mm
WL052-20W	20W	1800 Lm	Constant Current LED Driver	120°	280mm	65mm
WL053-24W	24W	2200 Lm	Constant Current LED Driver	120°	350mm	65mm

## ILLUSTRATION

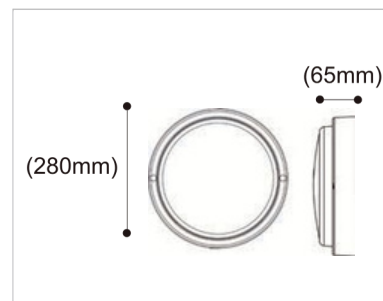

## LIGHT DISTRIBUTION

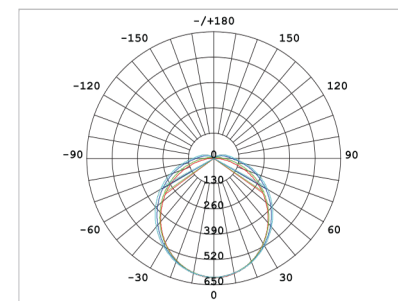

## OPTIONS:

- + Dimmable Driver 1 -10 / DALI



Backup Emergency Kit 1H/3H





# LED - WL01X IP65

## APPLICATIONS:

Suitable to be used in : Roof lightig, building surrounding, electrical and mechanical rooms and other similar outdoor applications.

## التطبيقات

مناسبة للاستخدام في : إضاءة السقف والأبنية المحيطة والغرف الكهربائية والميكانيكية ، وغيرها من التطبيقات الخارجية المماثلة .



## DESCRIPTIONS:

WL01 IP65 is a general purpose high quality LED bulkhead luminaire for outdoor applications. Using of high quality die cast aluminium housing and Opal PC diffuser make this product suitable for the most severe conditions with protection degree IP 65

## الوصف

WL01 IP65 هي عائلة متعددة الأغراض لإنارة عالية الجودة وتستخدم للتطبيقات في الهواء الطلق ، إن استخدام الجسم الألمنيوم المصبوب عالي الجودة وناشر من الأوبال يجعل هذا المنتج مناسباً لأقصى الظروف بدرجة حماية IP65 .





## General Specifications:

 Mounted	Surface / Wall
 Material	Die casted aluminium
 IP	IP65
 50,000 Hrs ( L70 @ 50C° )	
 -10 : 50°C	
 warranty	5 Years

## Optical Data:

 chips	High Quality LED Chip
 COB SMD	SMD
 Lm	100 lm/W
 beam angle	120°
 CCT	3000K/4000K/6500K
 CRI	> 80

## Electrical Data:

 LED Wattage	From 20W To 40W
 driver	Constant current LED driver
 Voltage	(220-240) Vac
 HZ	50-60 Hz
 PF	> 0.95

## SPECIFICATIONS:

Model	Wattage	Lumen	Light Source	Driver Type	Beam Angle	Ø	H
LED-WL011-20W	20W	2000 Lm	LED SMD Chips	Constant Current LED Driver	120°	265mm	120mm
LED-WL012-(30-40)W	(35-40)W	3500-4000 Lm	LED SMD Chips	Constant Current LED Driver	120°	365mm	143mm
LED-WL013-20W	20W	1800 Lm	LED SMD Chips	Constant Current LED Driver	120°	265mm	120mm
LED-WL014-(35-40)W	(30-40)W	3500-4000 Lm	LED SMD Chips	Constant Current LED Driver	120°	365mm	143mm
LED-WL015-20W	20W	1800 Lm	LED SMD Chips	Constant Current LED Driver	120°	265mm	120mm
LED-WL016-(35-40)W	(35-40)W	3500-4000 Lm	LED SMD Chips	Constant Current LED Driver	120°	365mm	143mm
LED-WL017-20W	20W	1800 Lm	LED SMD Chips	Constant Current LED Driver	120°	265mm	120mm
LED-WL018-(35-40)W	(35-40)W	(3500-4000) Lm	LED SMD Chips	Constant Current LED Driver	120°	365mm	143mm



## OPTIONS:

–  + Dimmable Driver 1 -10 / DALI

 Backup Emergency Kit 1H/3H

Other housing color upon request (RAL color)





# WUDL07 IP66

## APPLICATIONS:

Suitable to be used in : Entrance, gates and other similar applications

## التطبيقات

مناسبة للاستخدام في : المداخل والبوابات والتطبيقات المشابهة الأخرى .



## DESCRIPTIONS:

WUDL07X IP66 series is a professional LED wall mounting luminaire giving light up/down wards. Luminaire body Die-cast aluminum body with high corrosion resistance polyester powder paint resistant to corrosion at harsh weather conditions, Diffuser is high pure aluminum reflector and clear safety glass. Stainless steel screws and sealed with silicone gaskets.

## الوصف

WUDL07X IP66 عبارة عن وحدة إضاءة ليد مثبتة على الحائط بإضاءة لأسفل ولأعلى ، جسم الإنارة من الألومنيوم المسبوك مع طلاء بوليستر ذو مقاومة عالية للتآكل في الظروف الجوية القاسية ، الناشر هو عاكس من الألومنيوم عالي النقاء وزجاج حراري شفاف ، البراغى مصنعة من مادة الفولاذ المقاوم للصدأ ومزودة بجوانات من مادة السيليكون .

## General Specifications:

	Wall
	Die casted aluminium
	IP66
	50,000 Hrs ( L70 @ 25C° )
	-10 : 50°C
	5 Years

## Optical Data:

	High Quality LED Chip
	SMD
	80 lm/W
	2X50°
	3000K/4000K/6500K
	> 80

## Electrical Data:

	2X25W
	Constant current LED driver
	(220-240) Vac
	50-60 Hz
	> 0.95

## SPECIFICATIONS:

Model	Wattage	Lumen	Driver Type	Beam Angle	D	H
LED - WUDL071 2x25W IP66	50W	4000 Lm	Constant Current LED Driver	2X50°	160mm	200mm

## ILLUSTRATION

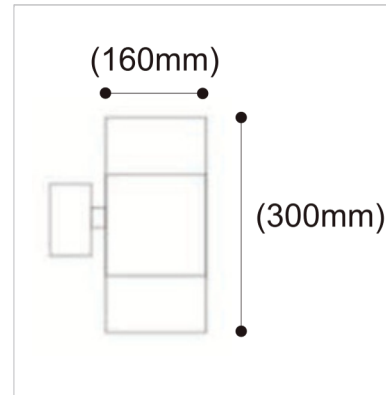

## LIGHT DISTRIBUTION

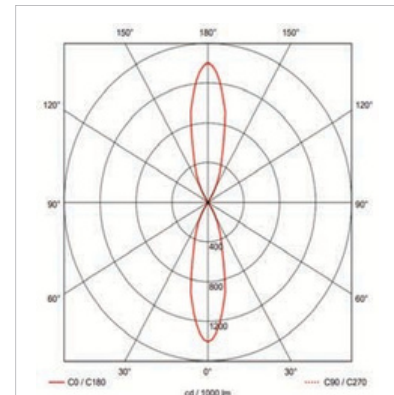

## OPTIONS:

– + Dimmable Driver 1 -10 / DALI

Backup Emergency Kit 1H/3H



OUTDOOR

# POST TOP LIGHT

**APPLICATIONS:**

Landscapes , Gardens , parks .



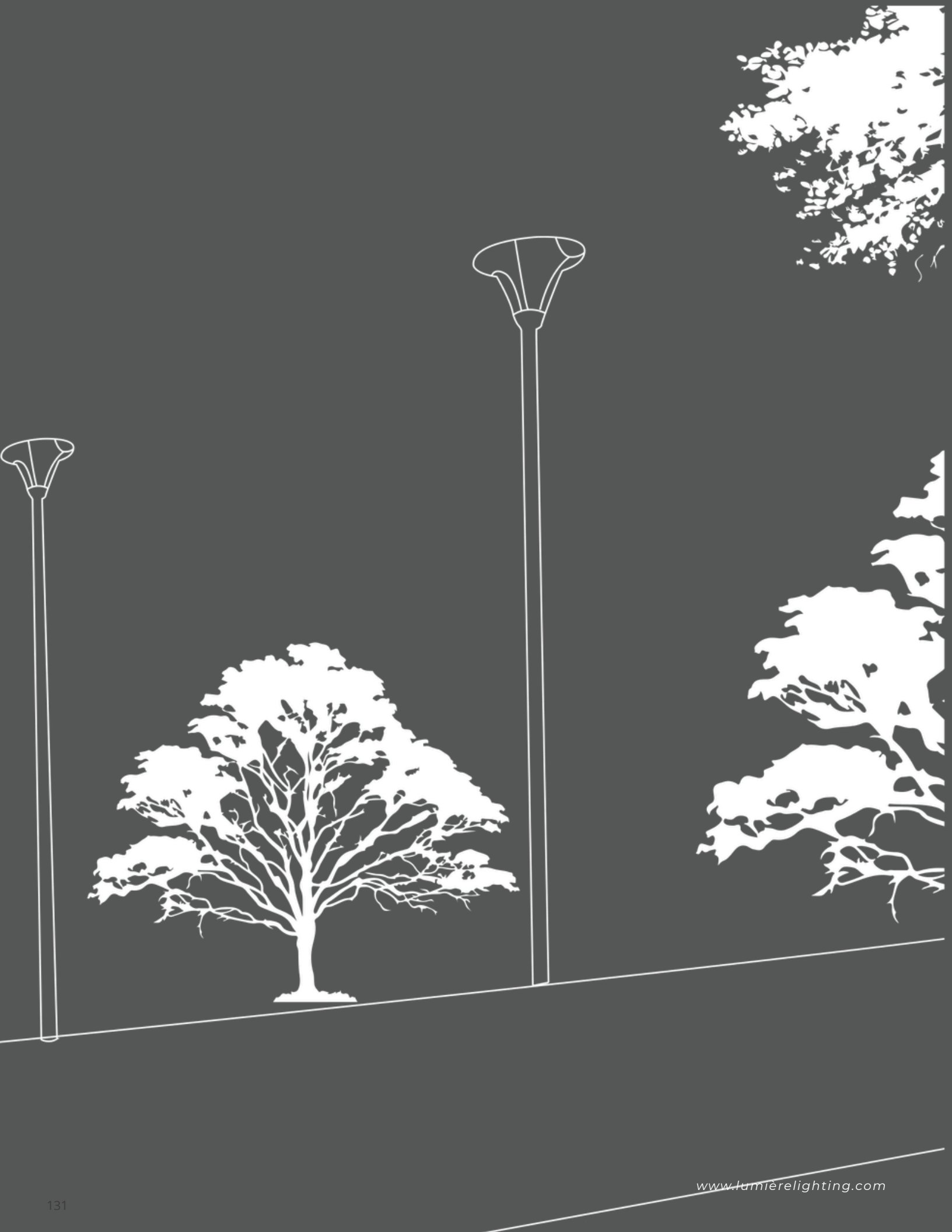





# GL - 13 IP65

## APPLICATIONS:

Suitable to be used in : Landscapes , Gardens , parks .

## التطبيقات

مناسبة للاستخدام في : المباني التجارية والمستشفيات والساحات والحدائق والممرات.

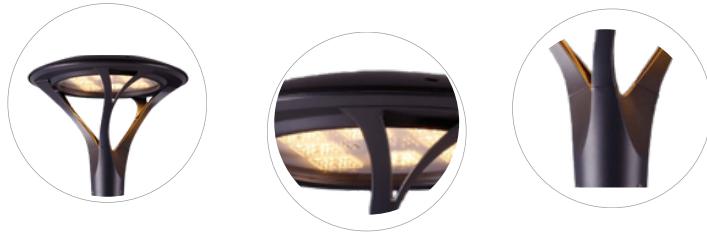

## DESCRIPTIONS:

LED GARDEN LIGHT-GL-13X is a professional LED street lighting solution designed to maintain high performance in most severe weather conditions (50°C, 90% RH) using high quality DieCast aluminum housing of IP 65 rating, IK08 .LED GARDEN LIGHT-NGL-10X has the ability to use medium power LEDs or high power LEDs .

## الوصف

إن LED GARDEN LIGHT-NGL-10X هو حل إضاءة LED احترافي مصمم للحفاظ على مستوى عالي الأداء في معظم الظروف الجوية القاسية (50 درجة مئوية ، 90 ٪ رطوبة نسبية) باستخدام هيكل مصنع من مادة الألومنيوم المسبوك عالي الجودة بدرجة حماية ضد العوامل الجوية IP65 ودرجة صلابة IK08 .

## General Specifications:

Mounted	Outdoor in Gardens & Parks
Material	Heavy duty die cast aluminum
IP	IP65
	50,000 Hrs ( L70B10 @ 25° )
	-10 : 40°C
warranty	5 Years

## Optical Data:

chips	High Quality LED Chip
COB SMD	SMD
Lm	100 lm/W
beam angle	120° (25°/45°/60°/90°/70°*150° For Narrow Beam as optional)
CCT	3000K/4000K/5700K
CRI	> 85

## Electrical Data:

LED Wattage	40W/60W
driver	Integrated Electronic LED
Voltage	(220-240) Vac
HZ	50-60 Hz
PF	> 0.95

## SPECIFICATIONS:

Model	Wattage	Lumen	Driver Type	L	W	H
NGL-131-40W	40W	4,000 lm	Constant Current LED Driver	477mm	477mm	474mm
NGL-132-60W	60W	6,000 lm	Constant Current LED Driver	477mm	477mm	474mm

## ILLUSTRATION

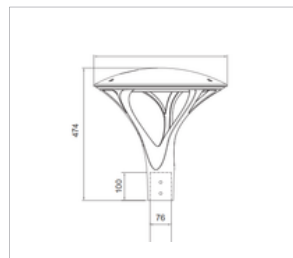

## LIGHT DISTRIBUTION

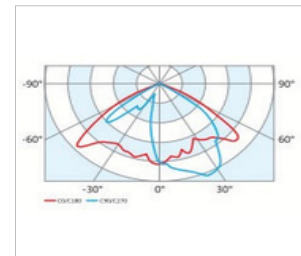

## OPTIONS:

– + Dimmable Driver 1 -10 / DALI

Ingress Protection Rating up to IP66 .





# GL - 11 IP66

## APPLICATIONS:

Suitable to be used in : Landscapes , Gardens , parks .

## التطبيقات

مناسبة للاستخدام في : المياني التجارية والمستشفيات والساحات والحدائق والممرات.

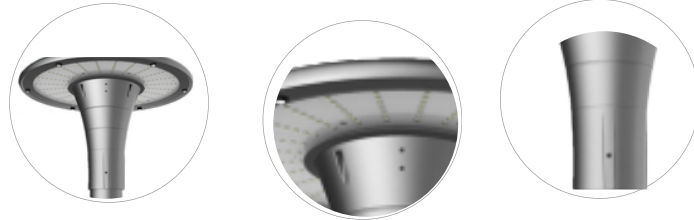

## General Specifications:

Mounted	Outdoor in Gardens & Parks
Material	Heavy duty die cast aluminum
IP	IP66
Life	50,000 Hrs ( L70B10 @ 25° )
Temp	-10 : 40°C
Warranty	5 Years

## Optical Data:

chips	High Quality LED Chip
COB SMD	SMD
Lm	100 lm/W
beam angle	120° (25°/45°/60°/90°/70°*150° For Narrow Beam as optional)
CCT	3000K/4000K/5700K
CRI	> 85

## Electrical Data:

LED Wattage	40W/60W
driver	Integrated Electronic LED
Voltage	(220-240) Vac
HZ	50-60 Hz
PF	> 0.95

## DESCRIPTIONS:

LED GARDEN LIGHT-GL-11X is a professional LED street lighting solution designed to maintain high performance in most severe weather conditions (50°C, 90% RH) using high quality DieCast aluminum housing of IP 65 rating, IK08 .LED GARDEN LIGHT-NGL-11X has the ability to use medium power LEDs or high power LEDs .

## الوصف

إن LED GARDEN LIGHT-NGL-11X هو حل إضاءة LED احترافي مصمم للحفاظ على مستوى عالي الأداء في معظم الظروف الجوية القاسية (50 درجة مئوية ، 90٪ رطوبة نسبية) باستخدام هيكل مصنع من مادة الألمنيوم المسبوك عالي الجودة بدرجة حماية ضد العوامل الجوية IP65 ودرجة صلابة IK08 .

## SPECIFICATIONS:

Model	Wattage	Lumen	Driver Type	L	W	H
NGL-111-35W	35W	4725 lm	Constant Current LED Driver	450mm	450mm	318mm
NGL-112-73W	73W	9855 lm	Constant Current LED Driver	490mm	490mm	558mm

## ILLUSTRATION

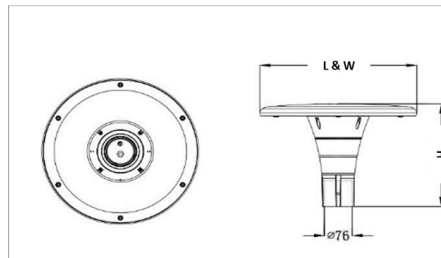

## LIGHT DISTRIBUTION

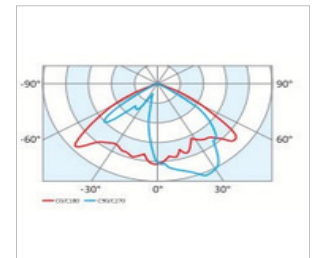

## OPTIONS:

- + Dimmable Driver 1 -10 / DALI

OUTDOOR

# BOLLARD

**APPLICATIONS:**

Gardens , Pathways , Sidewalk , Building Entrance .







# BOLLARD 04 IP66

## APPLICATIONS:

Suitable to be used in : Gardens , Pathways , Sidewalk , Building Entrance .

## التطبيقات

مناسبة للاستخدام في : الحدائق ، الممرات ، الأرصفت ، مداخل المباني .

## General Specifications:

 Mounted	Outdoor in Gardens & Parks
 Material	Die casted aluminium
 IP	IP66
 50,000 Hrs ( L70 @ 25C° )	
 -30 : 50°C	
 warranty	5 Years

## Optical Data:

chips	High Quality LED Chip
COB SMD	SMD
Lm	85 lm/W
beam angle	R03201, R03202, R03203
CCT	3000K/4000K/6500K
CRI	> 80

## Electrical Data:

LED Wattage	14W/24W
driver	LED Constant Current Driver
Voltage	(220-240) Vac
HZ	50-60 Hz
PF	> 0.95



## DESCRIPTIONS:

BOLLARD 04X IP66 series provide a professional lighting solution for residential and architectural lighting. Its die cast aluminium body, featuring high IK rating, protects all the fragile elements of the optics (light source, reflector, diffuser) free from any external mechanical impacts.

## الوصف

توفر حلا احترافيا للإضاءة السكنية والعمارة. جسمها المصنوع من الألمنيوم BOLED 04XIP66 ، والذي يتميز بتصنيف عالٍ، يحمي جميع العناصر الحساسة للبصريات (مصدر الضوء IK المصبوب، والعاكس، الناشر) من أي تأثيرات ميكانيكية خارجية.

## SPECIFICATIONS:

Model	Wattage	Lumen	Driver Type	D	H
BOLED 041 - 14W	14W	1190 Lm	Constant Current LED Driver	165mm	500mm
BOLED 042 - 14W	14W	1190 Lm	Constant Current LED Driver	165mm	900mm
BOLED 043 - 24W	24W	2040 Lm	Constant Current LED Driver	165mm	500mm
BOLED 044 - 24W	24W	2040 Lm	Constant Current LED Driver	165mm	900mm

## LIGHT DISTRIBUTION

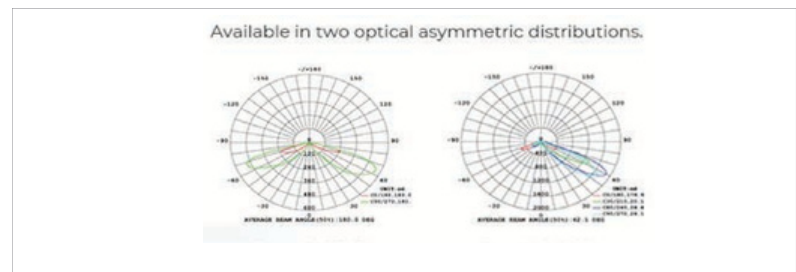

## OPTIONS:

–  Dimmable Driver 1 -10 / DALI

SIZE | LED-BOLED 042-14W

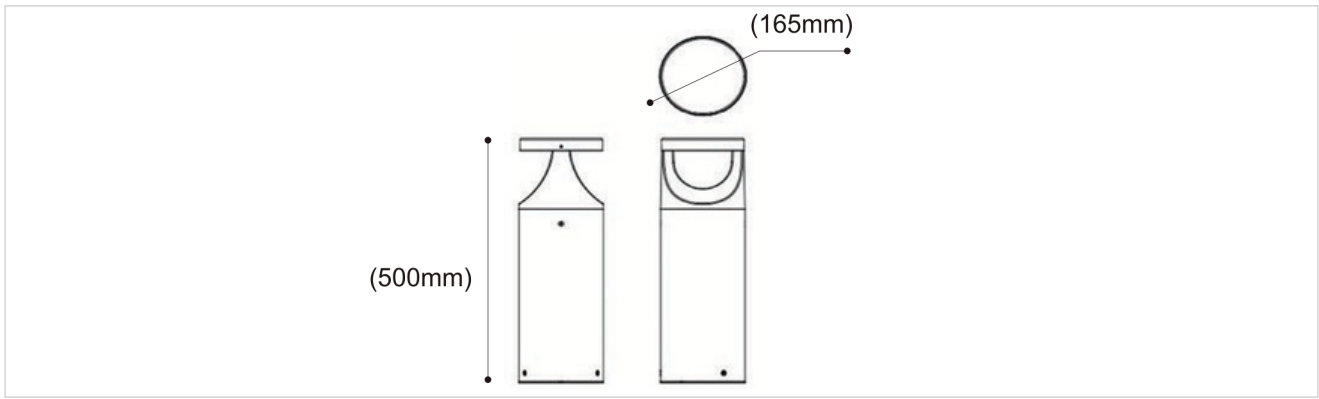

SIZE | LED-BOLED 042-14W

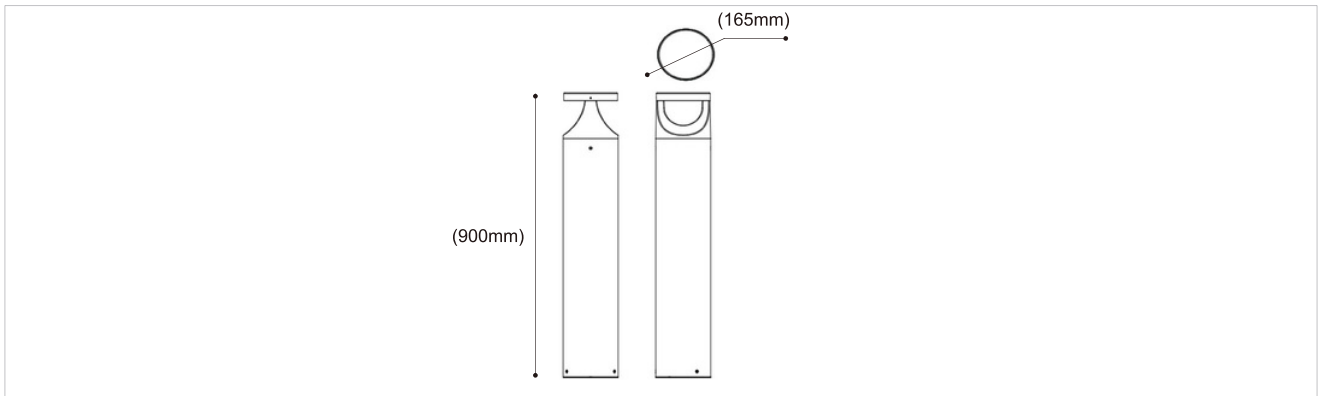

SIZE | LED-BOLED 043-24W

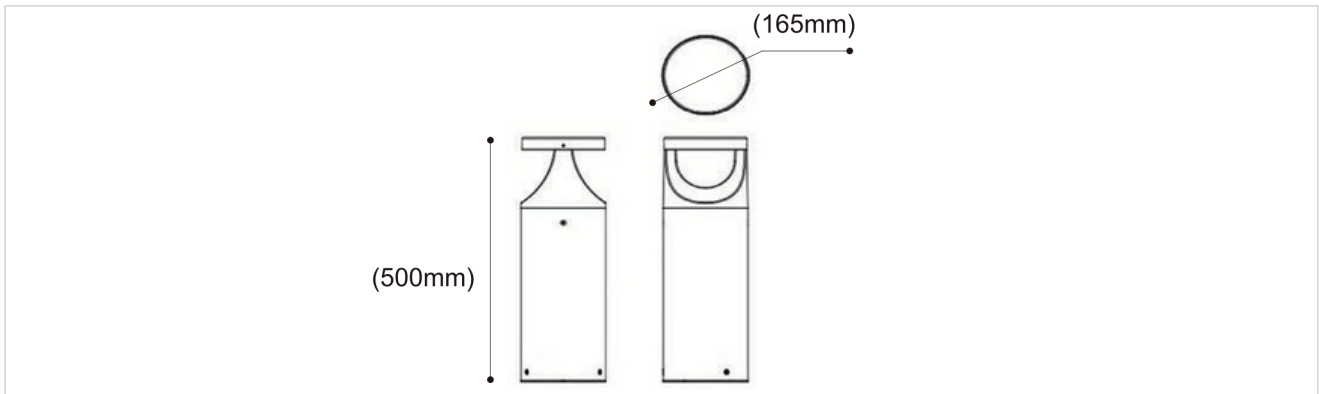

SIZE | LED-BOLED 044-24W

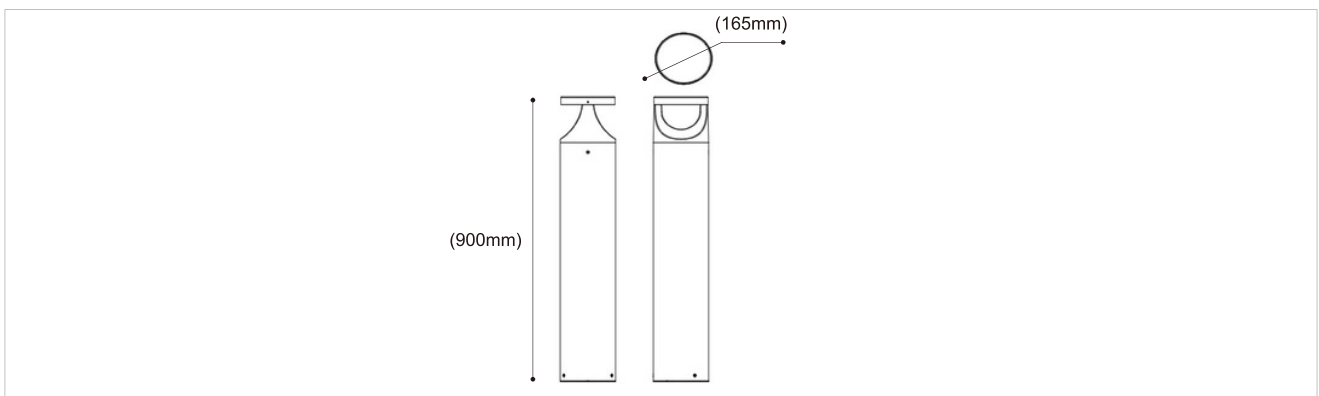

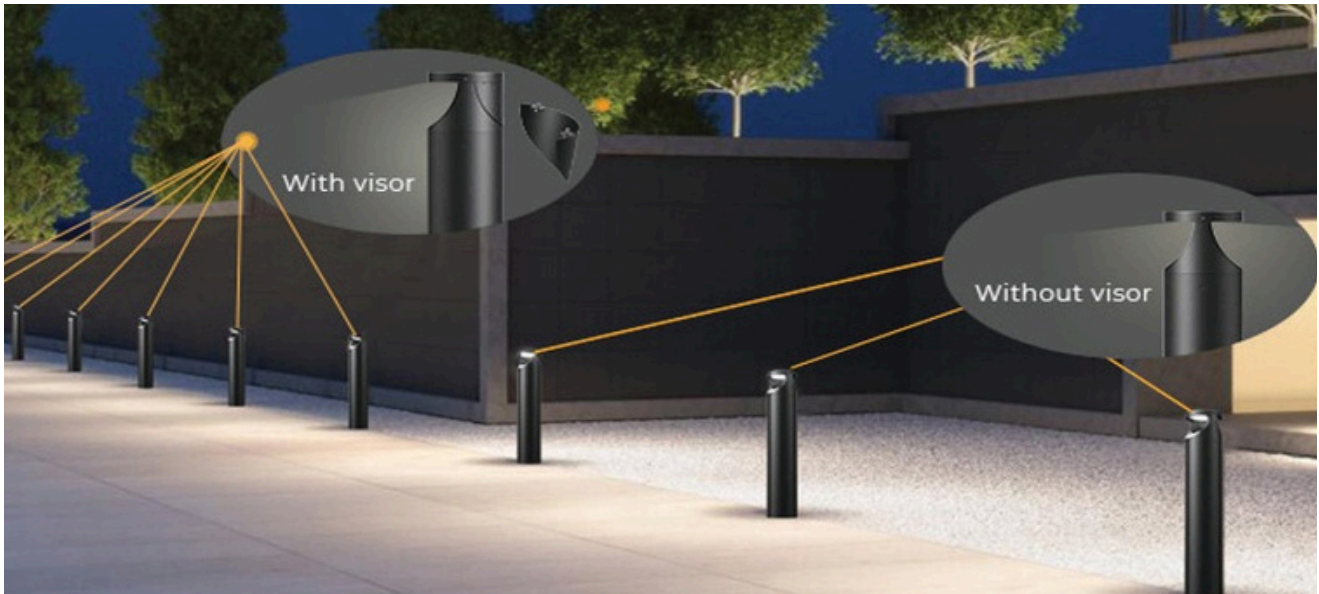

**Round House Side Shield**  
To reduce glare light

Code: BC-B01-02



**Terminal Box**

Code: CK-B01-01

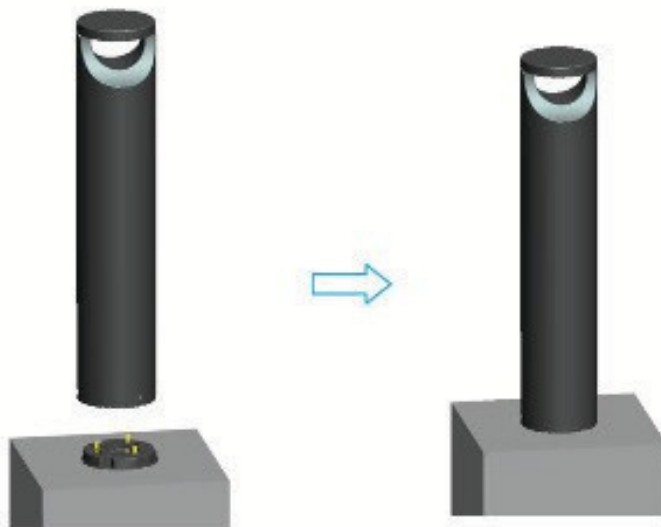





# LED - BOLED 03X IP65

## APPLICATIONS:

Suitable to be used in : For commercial buildings, hospitals, yards, parks and walkways.

## التطبيقات

مناسبة للاستخدام في : المباني التجارية والمستشفيات والساحات والحدائق والممرات.





## General Specifications:

 Mounted	Outdoor in Gardens & Parks
 Material	Die casted aluminium
 IP	IP65
 50,000 Hrs ( L70 @ 25C° )	
 -20 : 50°C	
 warranty	5 Years

## Optical Data:

 chips	High Quality LED Chip
 COB SMD	SMD
 Lm	80 lm/W
 beam angle	125°
 CCT	3000K/4000K/6500K
 CRI	> 85

## Electrical Data:

 LED Wattage	10W/20W/30W
 driver	Integrated Electronic LED
 Voltage	(220-240) Vac
 HZ	50-60 Hz
 PF	> 0.95



## DESCRIPTIONS:

BOLED 03 series provide a professional lighting solution for residential and architectural lighting. Its die cast aluminium body, featuring high IK rating, protects all the fragile elements of the optics (light source, reflector, diffuser) from any external mechanical impacts.

## الوصف

توفر حلًا احترافيًا للإضاءة السكنية والمعمارية. جسمها المصنوع من الألومنيوم BOLED 04XIP66 عالى، يحمي جميع العناصر الحساسة للبصريات (مصدر الضوء IK المصبوب، والذي يتميز بتصنيف العاكس، الناشر) من أي تأثيرات ميكانيكية خارجية.

## SPECIFICATIONS:

Model	Wattage	L/W	Driver Type	D	H
BOLED 03A- IP65	10W,20W,30W	80	Constant Current LED Driver	168mm	600mm,800mm, 1000mm
BOLED 03B-IP65	10W,20W,30W	80	Constant Current LED Driver	168mm	600mm,800mm, 1000mm
BOLED 03C-IP65	10W,20W,30W	80	Constant Current LED Driver	168mm	600mm,800mm, 1000mm
BOLED 03D-IP65	10W,20W,30W	80	Constant Current LED Driver	168mm	600mm,800mm, 1000mm

## LIGHT DISTRIBUTION

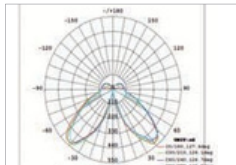

## SIZE | LED-BOLED 03D-IP65

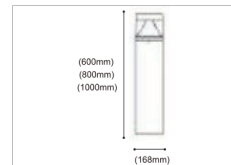

## SIZE | LED-BOLED 03C-IP65

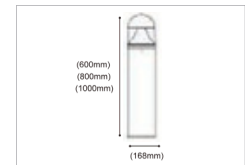

## SIZE | LED- BOLED

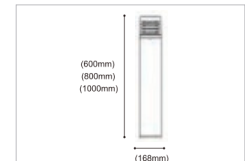

## OPTIONS:

–  Dimmable Driver 1 -10 / DALI

Standard electronic driver

# OUTDOOR LIGHT

## SPIKE

### APPLICATIONS:

Gardens , Pathways , Sidewalk , Building Entrance .



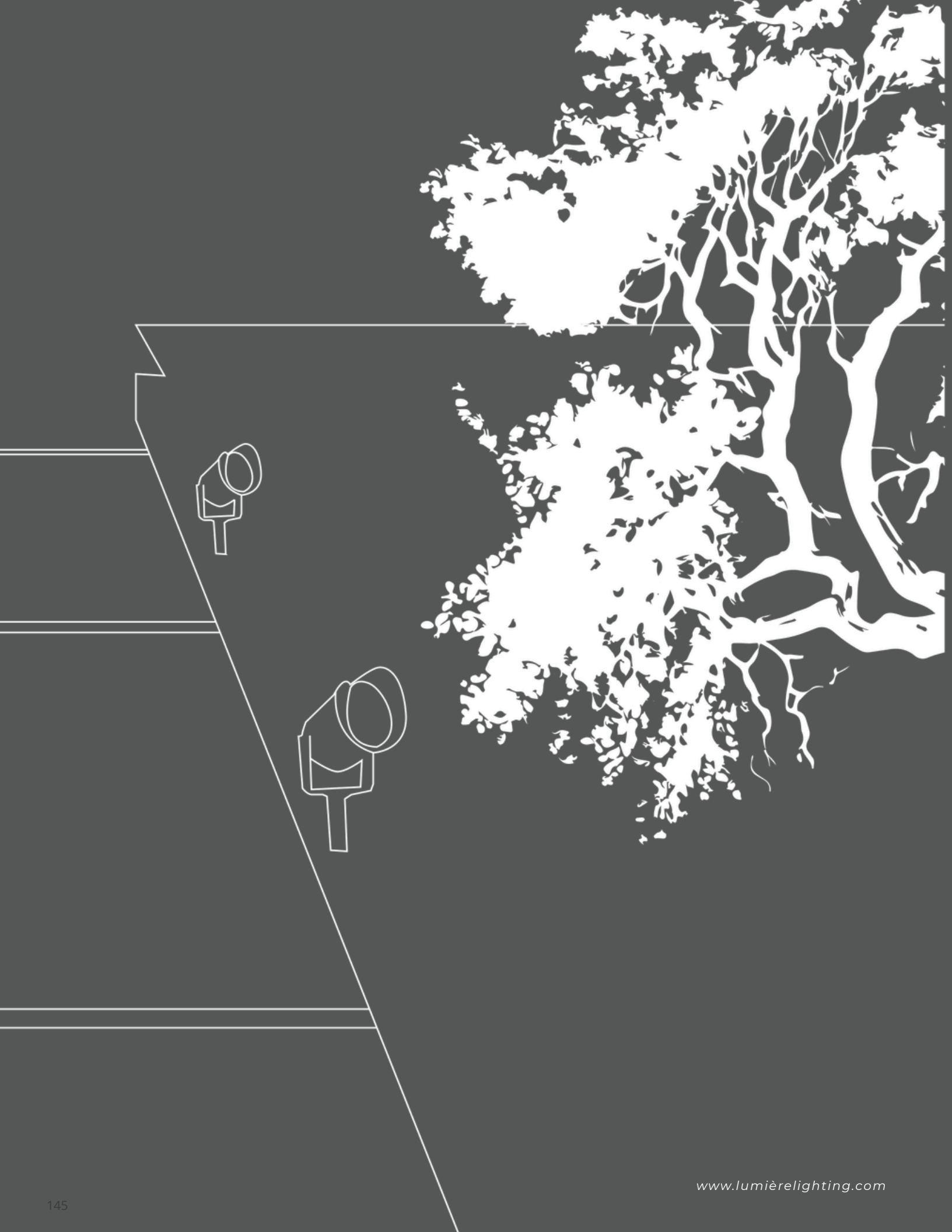





# SPIKE SP4X IP66

## APPLICATIONS:

Suitable to be used in : For commercial buildings, hospitals, yards, parks and walkways.

## التطبيقات

مناسبة للاستخدام في : المباني التجارية والمستشفيات والساحات والحدائق والممرات.



## DESCRIPTIONS:

SPIKELED 01X IP66 Can be described as following :

Heavy duty die-cast aluminum powder coating, construction corrosion resistant hardware allows total adjustability, suitable for either up or down lighting applications. Ideal for back yards, parks, signs and so on.

## الوصف

SPIKE SP4X IP66 يمكن وصفه كالتالي : جسم مصنع من الألمنيوم المصبوب للخدمة الشاقة ، درجة مقاومة عالية ضد التآكل ، يسمح بتوجيه الإضاءة في مدى زوايا مختلفة ، مناسب لتطبيقات الإضاءة لأعلى أو لأسفل.

## General Specifications:

	Spike Mounted
	High quality die cast aluminum
	IP66
	50,000 Hrs ( L70 @ 25° )
	-35 : 50°C
	5 Years

## Optical Data:

	High Quality LED Chip
	COB
	90 lm/W
	7°/15°/25°/40°/60°
	3000K/4000K/5700K/6500K
	> 80

## Electrical Data:

	10W/20W/30W
	Integrated Electronic LED
	(220-240) Vac
	50-60 Hz
	> 0.90

## SPECIFICATIONS:

Model	Wattage	Lumen	Driver Type	L	W	Spike Length
SP41 -5W/S	5W	450 Lm	Constant Current LED Driver	100mm	60mm	215mm
SP42 -10W/S	10W	900 Lm	Constant Current LED Driver	100mm	60mm	215mm

## ILLUSTRATION

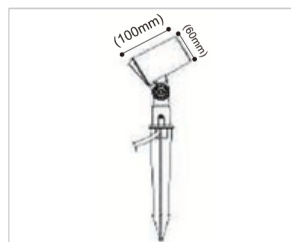

## LIGHT DISTRIBUTION

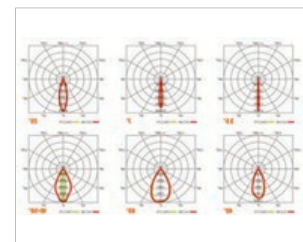

## OPTIONS:

- Dimmable Driver 1 -10 / DALI

Available Color Temperatures : 3000K , 4000K , 5700K , 6500K

OUTDOOR

# UPLIGHT

**APPLICATIONS:**

Landscape lighting designs,  
pathways

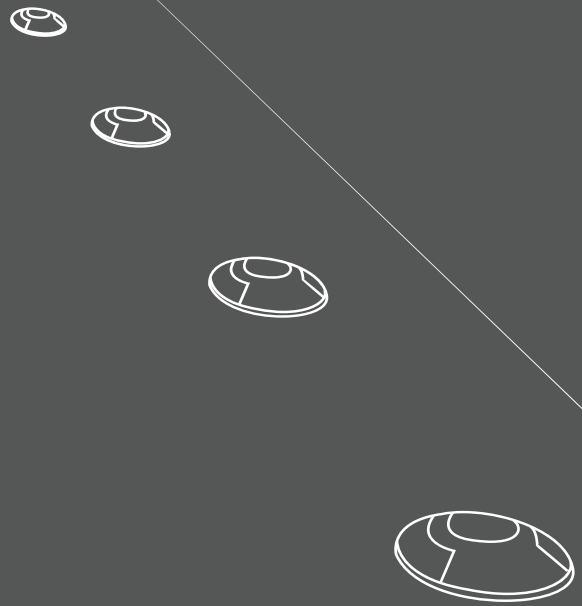







# DR O UPL - 14X IP67

## APPLICATIONS:

Suitable to be used in : Landscape lighting designs, facade lighting, pathways and other similar applications .

## التطبيقات

تصميم إضاءة المناظر الطبيعية ، إضاءة الواجهات ، الممرات والتطبيقات المشابهة الأخرى.

## General Specifications:

	Outdoor Buried in Ground
	Die casted aluminium
	IP67
	50,000 Hrs ( L70 @ 50C° )
	-10 : 50°C
	5 Years

## Optical Data:

	High Quality LED Chip
	COB
	62.5 lm/W
	57°
	3000K/4000K/6500K
	> 80

## Electrical Data:

	6.4W
	Constant current LED driver
	(100-240) Vac
	50-60 Hz
	> 0.5

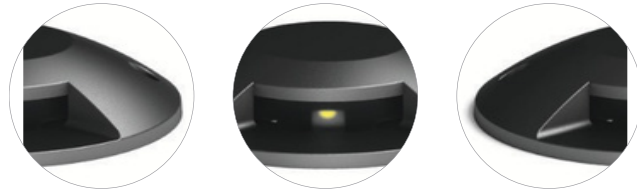

## DESCRIPTIONS:

LED Drive Over Uplight - DR O UPL-14 IP67 is surface-mounted luminaire. This is an innovative luminaire that provides a solution for a multitude of lighting applications on flat ground surfaces. The polycarbonate fixing plate isolating it from the ground. It can directly be fixed to the surface without the need for any recessing box or soakaway, making it significantly easy to install and maintain. Offer a high degree of flexibility. Die-casting aluminum housing with abrasive blasting surface treatment prior to the polyester painting process with high corrosion resistance. The luminaire will withstand a static weight of 5kN and the occasional transit of slow-moving vehicles.source.

## الوصف

DR O UPL 14 IP67 هي وحدة إنارة مثبتة على السطح توفر حلا للعديد من تطبيقات الإضاءة على أسطح الأرض. تحتوي على عزل عن الأرض بخامة البولي كاربونيت. يمكن تثبيته مباشرة على السطح دون الحاجة إلى أي صندوق تجويف ، مما يجعله سهل التركيب والصيانة بشكل ملحوظ. أو درجة عالية من المرونة. الجسم من الألمنيوم المصبوب بالقالب مع معالجة سطحية قبل عملية طلاء البوليستر بمقاومة عالية للتآكل. وحدة الإنارة تتحمل وزانا ثابتا يبلغ 5 كيلو نيوتن والعبور العرضي للمركبات بطيئة الحركة.

## SPECIFICATIONS:

Model	Wattage	Lumen	Driver Type	Beam Angle	D	H
NRU 141-6.4W	6.4W	400 Lm	Constant Current LED Driver	57°	200mm	42mm

## ILLUSTRATION

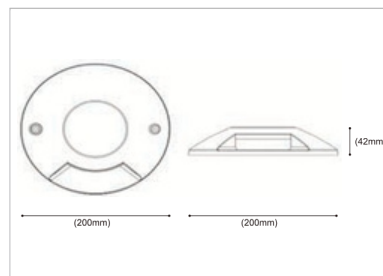

## LIGHT DISTRIBUTION

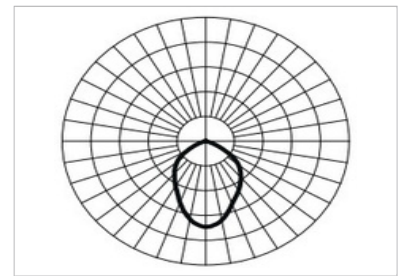

## OPTIONS:

– + Dimmable Driver 1 -10 / DALI





# UPL - 12 IP67

## APPLICATIONS:

Suitable to be used in : Landscape lighting designs, facade lighting, pathways and other similar applications .

التطبيقات مناسبة للاستخدام في : تصميم إضاءة المناظر الطبيعية ، إضاءة الواجهات ، الممرات والتطبيقات المشابهة الأخرى .





## General Specifications:

 Mounted	Outdoor Buried in Grounds
 Material	Die casted aluminium
 IP	IP67
 50,000 Hrs ( L70 @ 25C° )	
 -10 : 40°C	
 warranty	5 Years

## Optical Data:

 chips	High Quality LED Chip
 COB SMD	SMD
 Lm	70 lm/W
 beam angle	15°
 CCT	3000K/4000K/5700K
 CRI	> 80

## Electrical Data:

 LED Wattage	30W
 driver	Constant current LED driver
 Voltage	(220-240) Vac & 24 Vdc
 HZ	50-60 Hz
 PF	> 0.95



## DESCRIPTIONS:

LED UPLIGHT-UPL-12 is buried light with high water proof structure. Considering an- ti-glare, adopt down lighting level structure and mask frame. The lamp body used high pressure die-casting aluminum. The cover uses stain- less steel while the buried barrel uses high-quality corrosion-resistant nylon. The diffuser use thickened toughened glass, having an advan- tages in impact resistance and abrasion.

## الوصف

LED UPLIGHT UPL 12 هي وحدة إضاءة مدفونة مع ضوء أعلى ودرجة حماية عالية ضد المياه و الأتربة الجسم مصنوع من الألمنيوم المسبوك النقي . الغطاء مصنع من مادة الفولاذ المقاوم للتآكل و الصدأ . الناشر مصنع من الزجاج الحراري السميك المقاوم للصدمات .

## SPECIFICATIONS:

Model	Wattage	Lumen	Driver Type	Beam Angle	W	H
NRU121-30W/S	30W	2100 Lm	Constant Current LED Driver	5°,12.5°,20°,30°,45°,60°	260mm	195mm
NRU121-30W/RGB	30W	1200 Lm	Constant Current LED Driver	5°,12.5°,20°,30°,45°,60°	260mm	195mm

## ILLUSTRATION

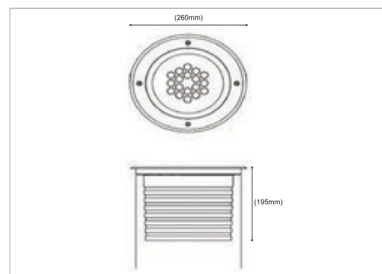

## LIGHT DISTRIBUTION

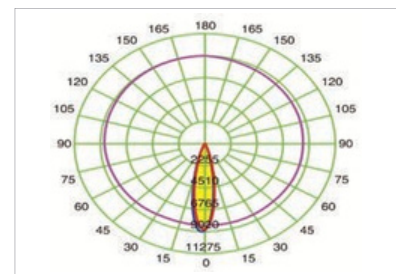

## OPTIONS:

-  + Dimmable Driver 1 -10 / DALI

OUTDOOR

# WALL WASHER

**APPLICATIONS:**

Commercial building, bridge, historic building

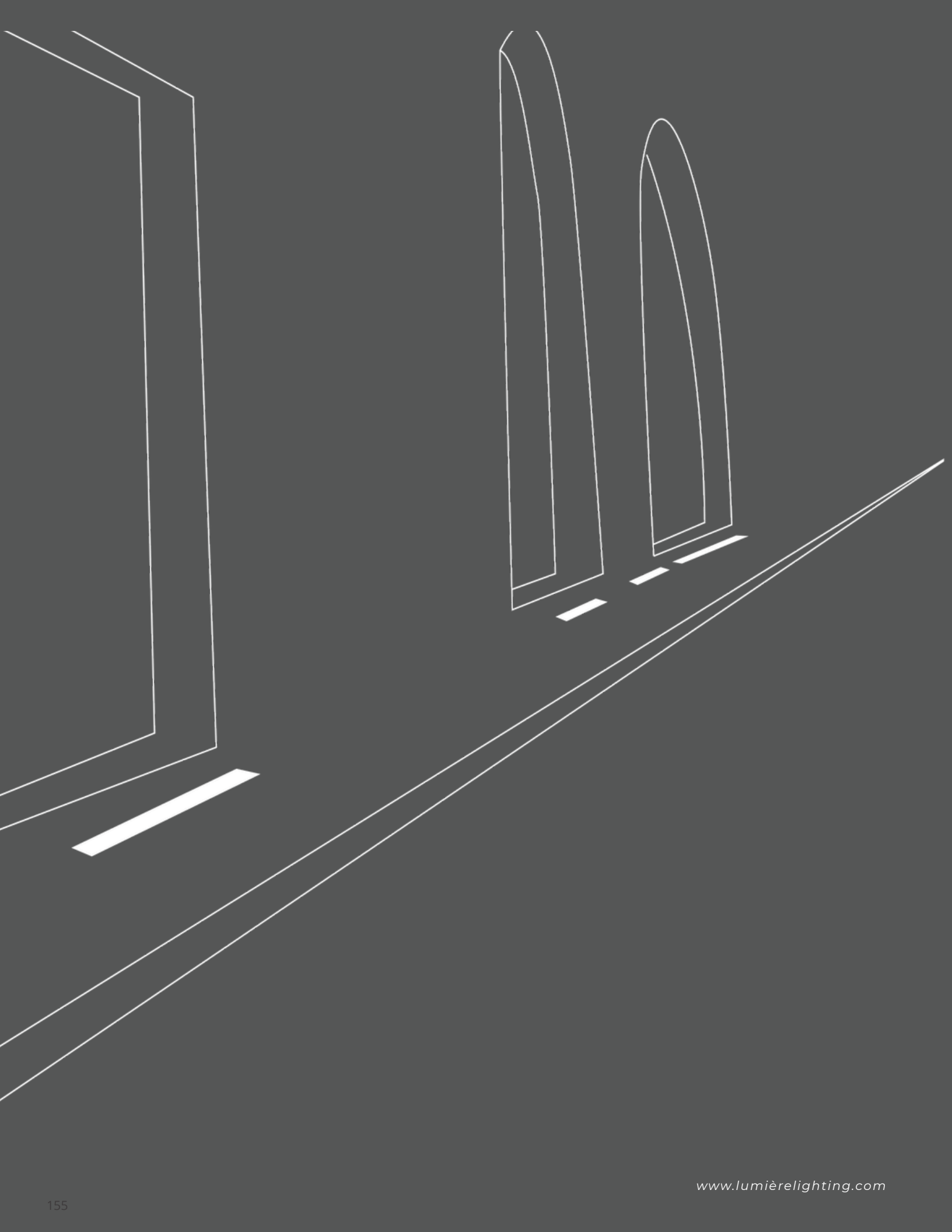





# WW06 IP67

## APPLICATIONS:

Suitable to be used in : Commercial building, bridge, historic building or special facade etc .

## التطبيقات

مناسبة للاستخدام في : مبنى تجارى ، جسر ، مبنى تاريخي أو واجهة خاصة وجميع التطبيقات المشابهة





## General Specifications:

 Mounted	Wall
 Material	Die casted aluminium
 IP	IP67
 L70 @ 25C°	50,000 Hrs ( L70 @ 25C° )
 -35 : 50°C	-35 : 50°C
 warranty	5 Years

## Optical Data:

 chips	High Quality LED Chip
 COB SMD	SMD
 Lm	40 lm/W
 beam angle	7°/25°/40°/60°/8x35°/10x50°
 CCT	3000K/4000K/6500K
 CRI	> 80

## Electrical Data:

 LED Wattage	36W
 driver	Constant current LED driver
 Voltage	(24) Vac
 HZ	50-60 Hz
 PF	> 0.95



## DESCRIPTIONS:

LED WALL WASHER - WW06 IP67 is stylish and modern design with aluminum alloy shell and overall molding process. Special structure design ensures good heat radiation, and reduces LED'S light wave effectively. The lamp can be configured with white light.

## الوصف

هو تصميم أنيق ومودم مع غلاف سبائك ، الألومنيوم وعملية التشكيل الشاملة ، يضمن تصميم الهيكل بشكل فعال ، يمكن المصباح بالضوء الأبيض LED الخاص اشعاعا حراريا جيدا ويقلل من تلاشي ضوء .

## SPECIFICATIONS:

Model	Wattage	Lumen	Driver Type	L	W	H
WW061-36W	36W	1440 Lm	Constant Current LED Driver	1000mm	47mm	53mm
WW061-36W	36W	1440 Lm	Constant Current LED Driver	1000mm	47mm	53mm

## ILLUSTRATION

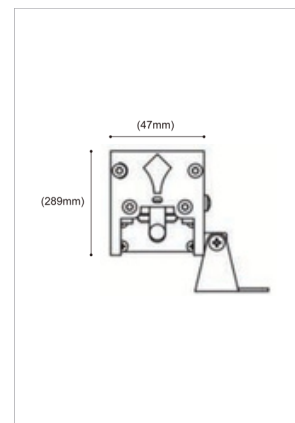

## LIGHT DISTRIBUTION

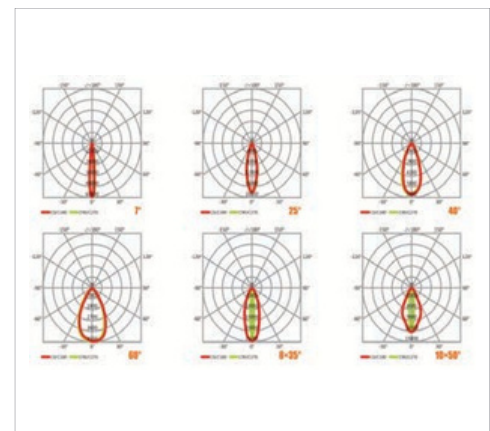

## OPTIONS:

-  + Dimmable Driver 1-10 / DALI

OUTDOOR

# STEP LIGHT

**APPLICATIONS:**

Wall, stairs and other similar outdoor applications.







# SP01 IP65





## APPLICATIONS:

Suitable to be used in : Wall, stairs and other similar outdoor applications.

## التطبيقات

مناسبة للاستخدام في : الجدار والسلالم والتطبيقات الخارجية المماثلة الأخرى .





## General Specifications:

 Mounted	Wall recessed
 Material	Die-cast powder coated
 IP	IP65
 50,000 Hrs ( L70 @ 25C° )	
 -10 : 50°C	
 warranty	5 Years

## Optical Data:

 chips	High Quality LED Chip
 COB SMD	SMD
 Lm	87.5 lm/W
 beam angle	Asymmetric
 CCT	3000K/4000K
 CRI	> 80

## Electrical Data:

 LED Wattage	8W
 driver	Constant current LED driver
 Voltage	(220-240) Vac
 HZ	50-60 Hz
 PF	> 0.95



High voltage type



Low voltage type



ABS mounting sleeve

## DESCRIPTIONS:

SP01 Series is a wall recessed asymmetric mounting luminaire for outdoor applications. Using of high quality die cast housing and tempered protection glass, moulding shaped silicon seal integrated LED driver. Make this product suitable for the most severe conditions with protection degree IP 65.

## الوصف

SP01 عبارة عن وحدة إنارة مثبتة على الحائط متماثلة للتطبيقات الخارجية. باستخدام غلاف مصبوب عالي الجودة وزجاج حماية مقسى، يجعل هذا المنتج مناسب لأشد الظروف مع درجة الحماية IP65.

## SPECIFICATIONS:

Model	Wattage	Lumen	Driver Type	L	W	H
SP01X-LED 8W/S	8W	700 Lm	Constant Current LED Driver	255mm	76mm	70mm

## ILLUSTRATION

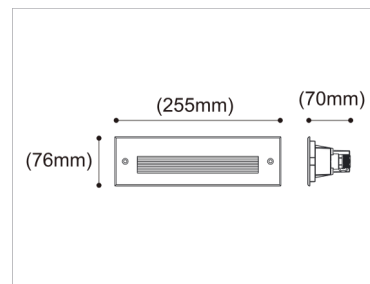

## LIGHT DISTRIBUTION

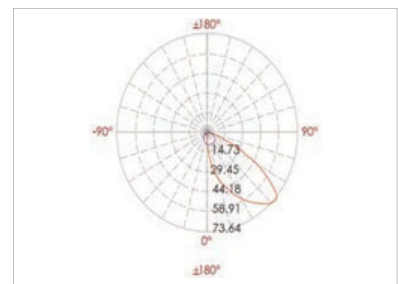

## OPTIONS:

-  Dimmable Driver 1 -10 / DALI



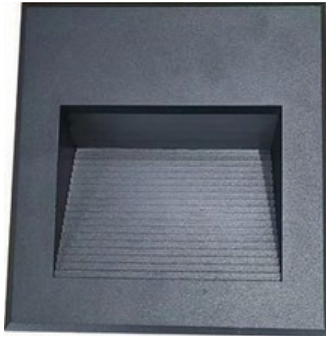

# SP07 IP65

## APPLICATIONS:

Suitable to be used in : Accent lighting in shopping center, retail store, museum, gallery, etc.

التطبيقات مناسبة للاستخدام في : إضاءة مميزة في مركز التسوق ومتجر البيع بالتجزئة والمتحف والمعرض وما إلى ذلك .

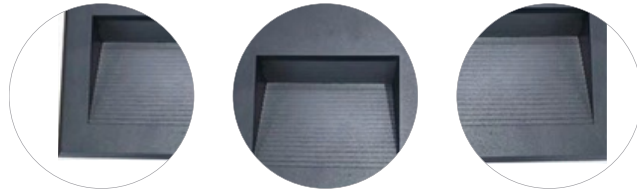

## DESCRIPTIONS:

SP07X IP65 is a wall recessed asymmetric mounting luminaire for outdoor applications. Using of high quality die cast housing and tempered protection glass, moulding shaped silicon seal integrated LED driver. Make this product suitable for the most severe conditions with protection degree IP65.

## الوصف

هي وحدة إنارة متماثلة مثبتة على الحائط للتطبيقات الخارجية ، جسم الكشاف مصنع من الألمنيوم المسبوك عالي الجودة وزجاج حماية مقسى ووحدة تحكم LED متكامل مما يجعل هذا المنتج مناسباً لأقصى الظروف بدرجة حماية IP65 .

## General Specifications:

Mounted	Wramped
Material	Die casted aluminium
IP	IP65
	50,000 Hrs ( L70 @ 25C° )
	-10 : 40°C
warranty	5 Years

## Optical Data:

chips	High Quality LED Chip
COB SMD	SMD
Lm	62.5 lm/W
beam angle	°45 Asymmetrical
CCT	3000K/4000K/6500K
CRI	> 80 , > 90

## Electrical Data:

LED Wattage	5W
driver	Constant current LED driver
Voltage	(220-240) Vac
HZ	50-60 Hz
PF	> 0.95

## SPECIFICATIONS:

Model	Wattage	Lumen	Driver Type	Color Temoerature	W	H
LED-WL071-5W	5W	312.5 Lm	Constant Current LED Driver	3000K/4000K/ 6500K	100mm	170mm

## ILLUSTRATION

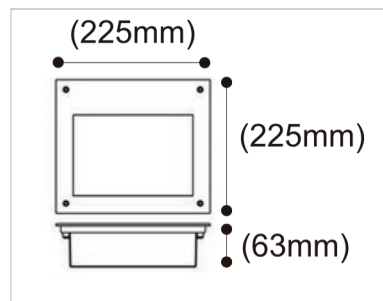

## LIGHT DISTRIBUTION

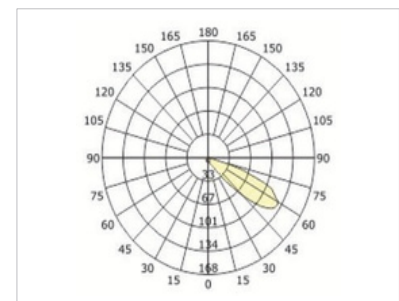

## OPTIONS:

- + Dimmable Driver 1 -10 / DALI

 Backup Emergency Kit 3H





# STEP01 IP67

## APPLICATIONS:

Suitable to be used in : Wall, stairs and other similar outdoor applications.

## التطبيقات

مناسبة للاستخدام في : الجدار والسلالم والتطبيقات الخارجية المماثلة الأخرى .





## General Specifications:

 Mounted	Wramped
 Material	Die casted aluminium
 IP	IP67
 50,000 Hrs ( L70 @ 50C° )	
 -20 : 50°C	
 warranty	5 Years

## Optical Data:

 chips	High Quality LED Chip
 COB SMD	SMD
 Lm	100 lm/W
 beam angle	45°
 CCT	3000K/4000K/6500K
 CRI	> 80

## Electrical Data:

 LED Wattage	20W
 driver	Constant current LED driver
 Voltage	(220-240) Vac
 HZ	50-60 Hz
 PF	> 0.95



## DESCRIPTIONS:

LED - STEP01X IP67 is a wall recessed asymmetric mounting luminaire for outdoor applications. Using of high quality die cast housing and tempered protection glass, moulding shaped silicon seal integrated LED driver. Make this product suitable for the most severe conditions with protection degree IP 65.

## الوصف

STEP01X IP67 هي وحدة إنارة غير متماثلة مثبتة على الحائط للتطبيقات الخارجية جسم الكشاف مصنع من الألمونيوم المسبوك عالي الجودة وزجاج حماية مقسى وحدة تحكم LED متكامل ، مما يجعل هذه المنتج مناسباً لأقسى الظروف بدرجة حماية IP65 .

## SPECIFICATIONS:

Model	Wattage	Lumen	Driver Type	Beam Angle	W	H
LED-STEP01X -20W	20W	2000 Lm	Constant Current LED Driver	45°	270mm	140mm

## ILLUSTRATION

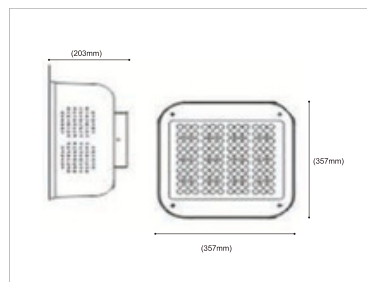

## LIGHT DISTRIBUTION

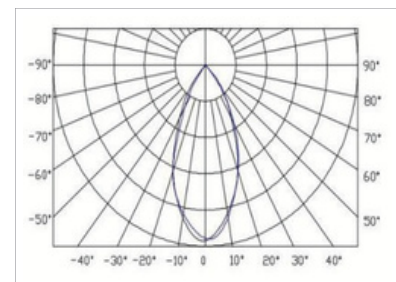

## OPTIONS:

-  Dimmable Driver 1 -10 / DALI

OUTDOOR

# GAS STATION LIGHT

**APPLICATIONS:**

Architectural Lighting , Gas stations , Under bridges .

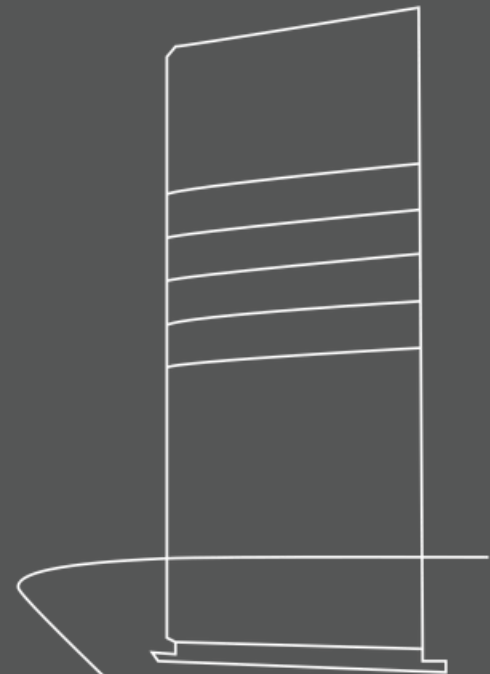
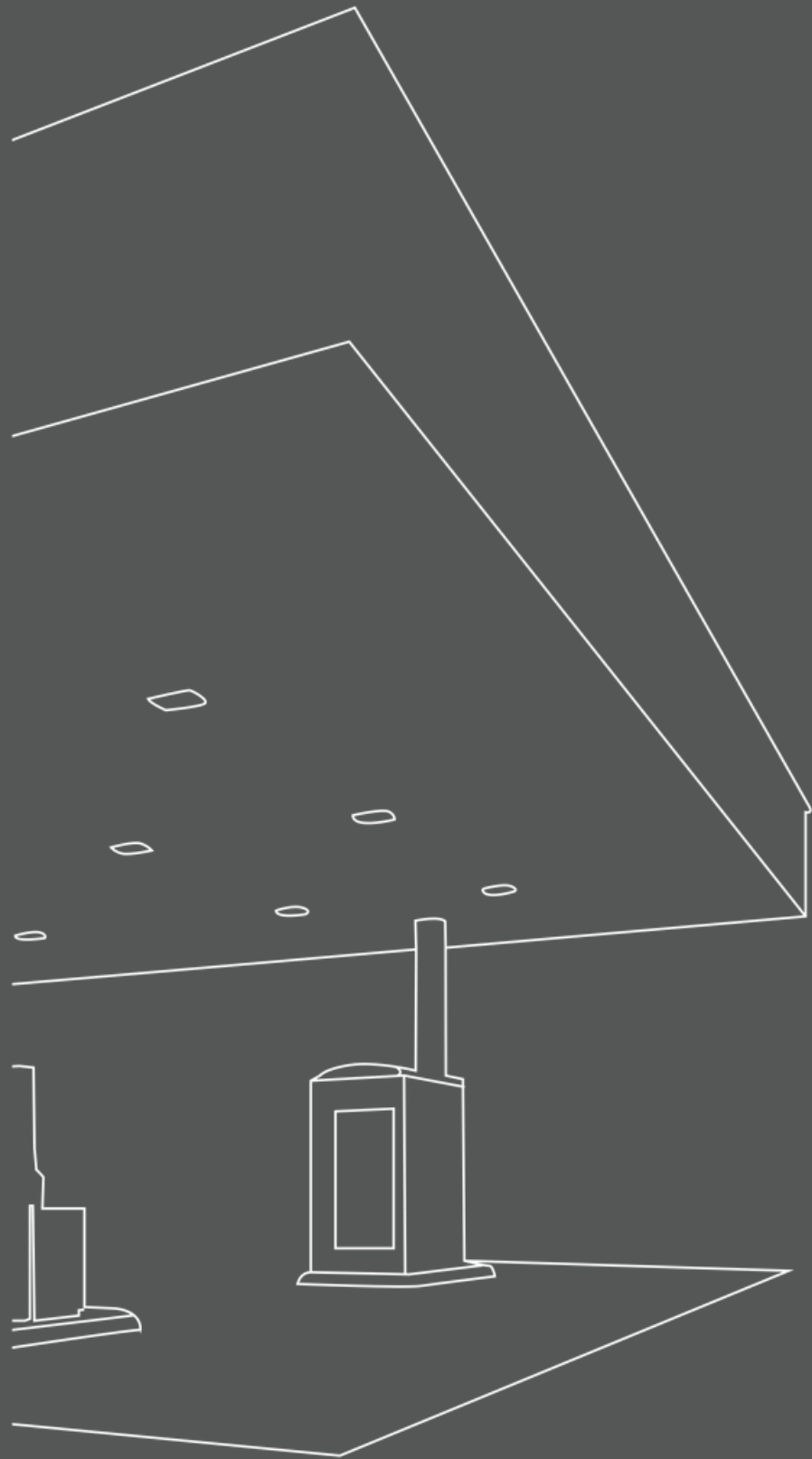





# LOW BAY 01 IP65







## APPLICATIONS:

Suitable to be used in : Architectural Lighting , Gas stations , Under bridges .

## التطبيقات

مناسبة للاستخدام في : الإنارة المعمارية ، محطات الوقود ، تحت الجسور .





### General Specifications:

 Mounted	Recessed Mounting
 Material	High quality die cast aluminum
 IP	IP65
 50,000 Hrs ( L70 @ 50C° )	50,000 Hrs ( L70 @ 50C° )
 -20 : 50°C	-20 : 50°C
 warranty	5 Years

### Optical Data:

 chips	High Quality LED Chip
 COB SMD	SMD
 Lm	130 lm/W
 beam angle	90° , 90°
 CCT	3000K/4000K/6500K
 CRI	> 70

### Electrical Data:

 LED Wattage	80W/100W/120W
 driver	Constant current LED driver
 Voltage	(100-277) Vac
 HZ	50-60 Hz
 PF	> 0.95



## DESCRIPTIONS:

LOW BAY 01 IP65 with LED technique is the standard solution for outdoor gas stations , under bridges , Architectural Lighting areas. It is equipped with high quality electronic driver with protection against sand & water IP65 as per Saudi & international standards. The housing is die-cast aluminum with high quality electrostatic painting.

## الوصف

LOW BAY 01 IP65 هي وحدة إنارة بتقنية ليد وهي الحل القياسي لمحطات الوقود الخارجية وتحت الجسور ، ومناطق الإضاءة المعمارية. مزود بمحرك إلكتروني عالي الجودة مع حماية ضد الرمل والماء IP65 حسب المواصفات السعودية والعالمية. السكن مصنوع من الألمنيوم المصبوب مع طلاء إلكتروستاتيكي عالي الجودة.

## SPECIFICATIONS:

Model	Wattage	Lumen	Driver Type	L	W	H
LED-LOW BAY 011 IP65-80W	80W	10,400 Lm	Constant Current LED Driver	357mm	357mm	203mm
LED-LOW BAY 012 IP65-100W	100W	13,000 Lm	Constant Current LED Driver	357mm	357mm	203mm
LED-LOW BAY 011 IP65-120W	120W	15,600 Lm	Constant Current LED Driver	357mm	357mm	203mm

## ILLUSTRATION

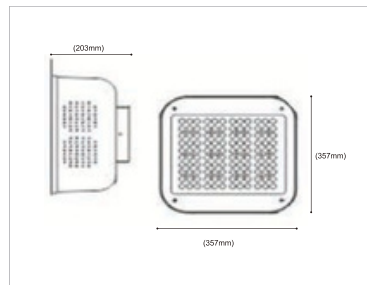

## LIGHT DISTRIBUTION

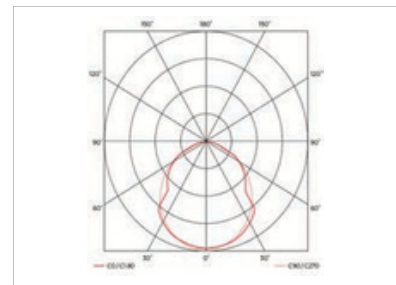

## OPTIONS:

-  Dimmable Driver 1-10 / DALI

OUTDOOR

# POOL LIGHT

**APPLICATIONS:**

fountains, pools, ponds, water gardens

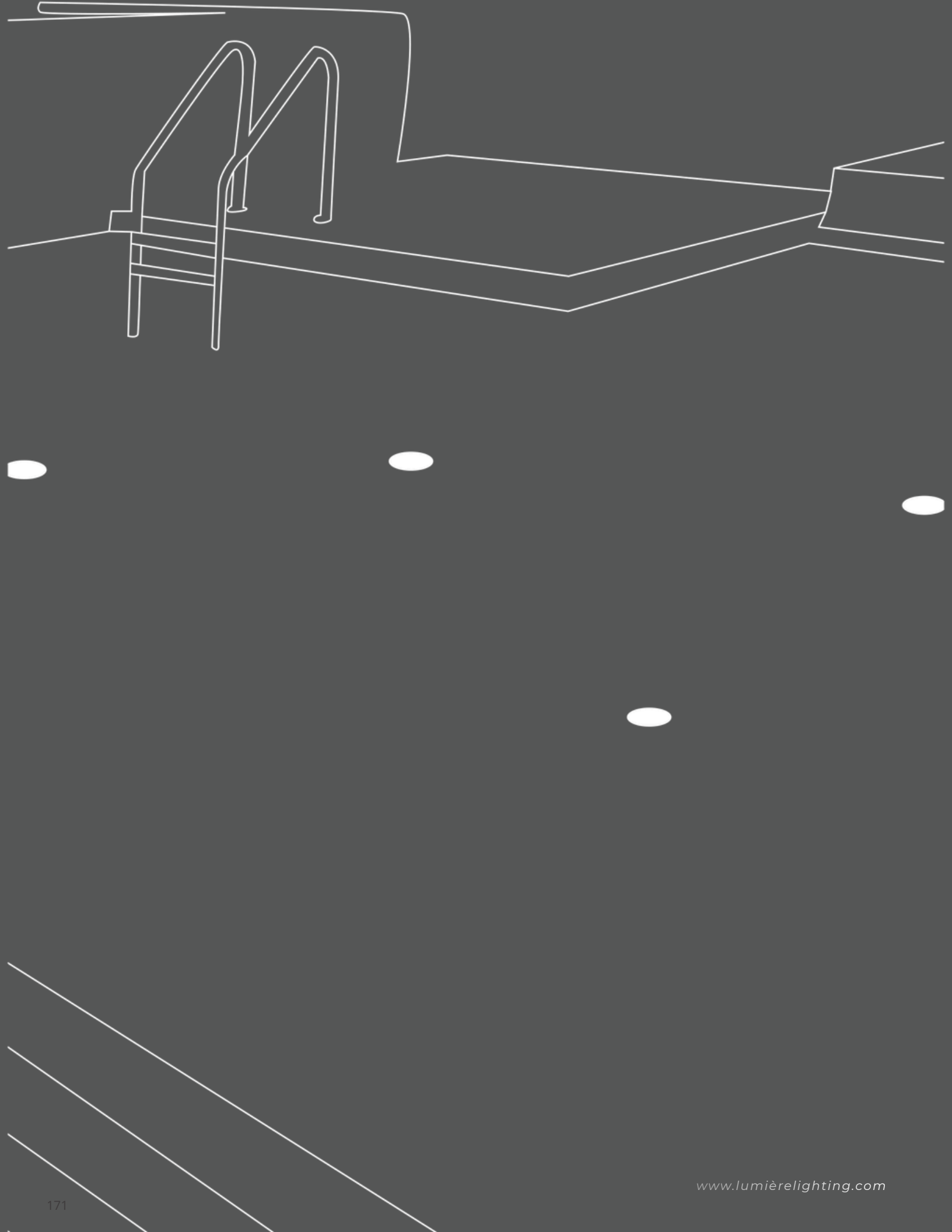





# PL01 IP68

## APPLICATIONS:

Suitable to be used in : fountains, pools, ponds, water gardens etc. for atmospheric or underwater lighting.

التطبيقات مناسبة للاستخدام في : النوافير والمساح والبرك والحدائق المائية وما إلى ذلك لإضاءة الغلاف الجوي أو تحت الماء.





## General Specifications:

 Mounted	Recessed
 Material	Die casted aluminium
 IP	IP68
 50,000 Hrs ( L70 @ 25C° )	
 -20 : 40°C	
 warranty	5 Years

## Optical Data:

 chips	High Quality LED Chip
 COB SMD	SMD
 Lm	70 lm/W
 beam angle	15°/30°/45°/60°
 CCT	3000K/4000K/6500K
 CRI	> 80

## Electrical Data:

 LED Wattage	8.9W
 driver	Constant current LED driver
 Voltage	(12-24) Vac
 HZ	50-60 Hz
 PF	> 0.95



Built-in Radiator



Use the silicone with good stickiness and thermal effect for reach the purpos of radiating and prevent moisture

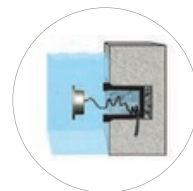

Water must be allowed to fo iside and outside sleeve freely without leaking from other side

## DESCRIPTIONS:

PL01 IP68 is a Landscape Lighting IP68 LED pool light is suitable as underwater spotlight for fountains, pools, ponds, water gardens etc. for atmospheric or underwater lighting.

## الوصف

PL01X P68 عبارة عن سلسلة إضاءة للمساح IP68 LED مناسبة كضوء كشف تحت الماء للنوافير ، حمامات السباحة ، البرك ، الحدائق المائية وما إلى ذلك لإضاءة تحت الماء .

## SPECIFICATIONS:

Model	Wattage	Lumen	Driver Type	L	W	H
LED-PL011-8.9W	8.9W	623 Lm	Constant Current LED Driver	135mm	135mm	120mm

## ILLUSTRATION



## LIGHT DISTRIBUTION

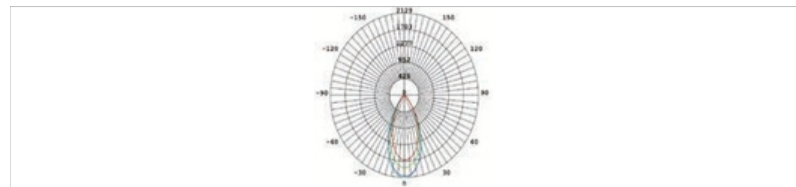

## OPTIONS:

-  Dimmable Driver 1 -10 / DALI

 Backup Emergency Kit 3Hr

OUTDOOR

# SOLAR SYSTEM

**APPLICATIONS:**

Solar Energy Application



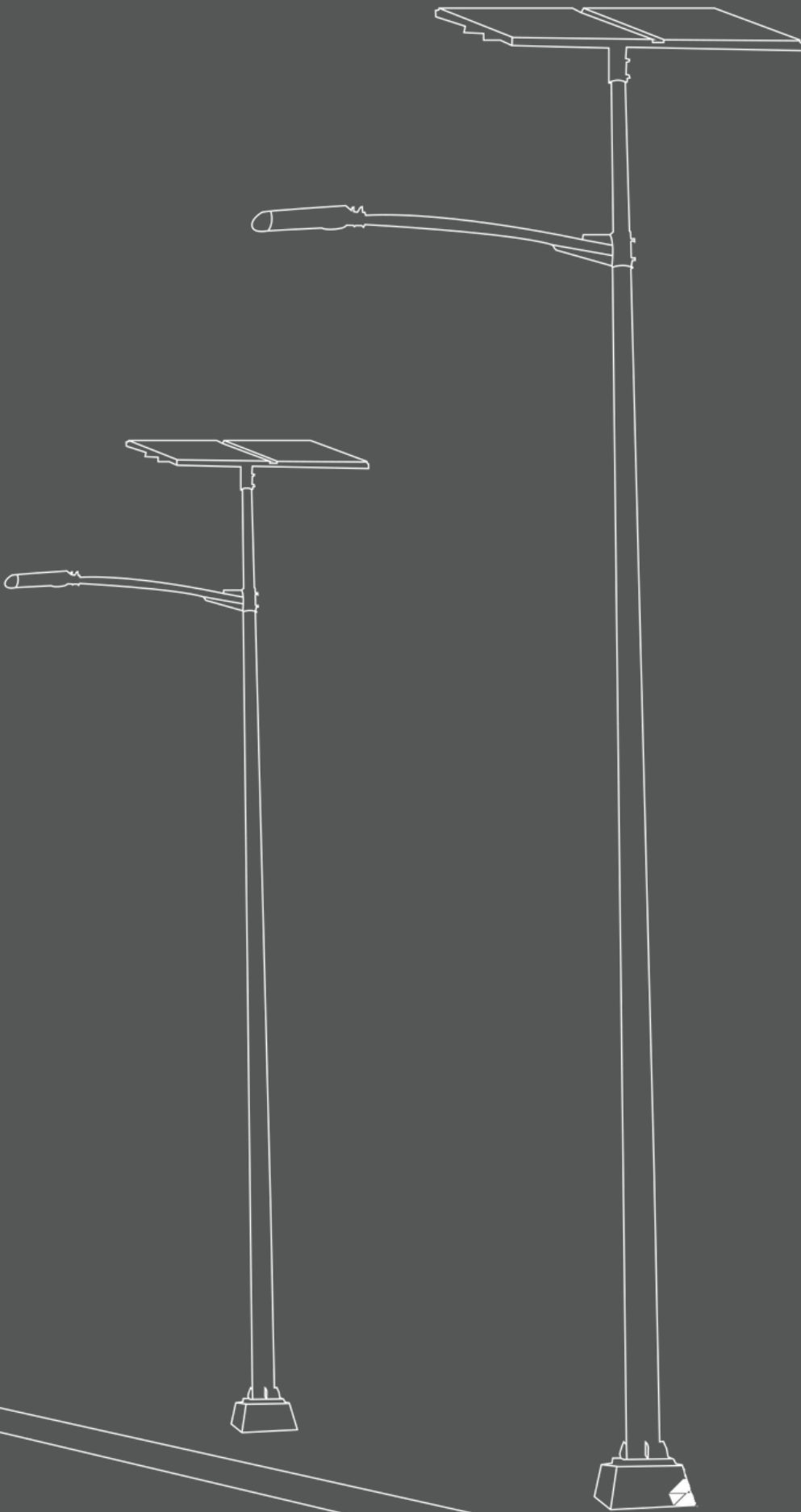





# EO - SST Series

## APPLICATIONS:

Suitable to be used in : Street lighting, urban area lighting .

التطبيقات  
مناسبة للاستخدام في : إنارة الشوارع و المناطق الحضرية .

### General Specifications:

 Mounted	Pole Mounting
 Material	Die casted aluminium
 IP	IP66
 L70 @ 25C°	52,000 Hrs ( L70 @ 25C° )
 -20 : 55°C	-20 : 55°C
 warranty	5 Years

### Optical Data:

chips	High Quality LED Chip
COB SMD	SMD
Lm	130 : 150lm/W
beam angle	70x140°/95x150°
CCT	2500~6500K
CRI	> 70

### Electrical Data:

LED Wattage	30W/50W/60W/90W
driver	Constant current LED driver
Voltage	(12-24) Vac
HZ	50-60 Hz
PF	-

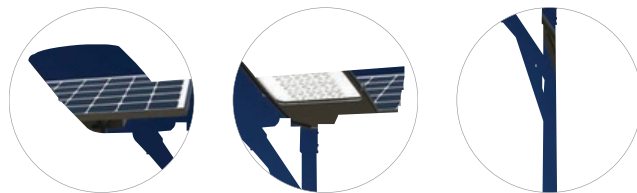

### Introduction :

Solar powered outdoor lighting products are ideal for lighting the area in remote locations where the electricity is unavailable or erratic. Even in urban areas, these find great usage to reduce dependency on conventional power and contribute towards green energy. Reliable and long life makes this solution effective in fulfilling our present and future lighting requirements

### KEY FEATURES

- System Light Efficacy 130:150 LPW with high performance LED chips.
- Solar powered-No need for any other power supply or electrical cabling.
- Automatic dusk to dawn operation(or timer options).
- Highly efficient monocrystalline silicon photovoltaic panels.
- Easy to Install and Maintain.

## System & Hardwares





- 
**Automatic Light On/Off & Dimming Control**
  - By time setting
  - On/off or dimming with motion sensor detection
  - On/off or dimming with photoval detection
- 
**Accurate Operation & Fault Monitor**
  - Real-time monitor on each light working status
  - Accurate report on fault detection
  - Provide location of fault, no patrol required
  - Collect each light operation data, such as voltage, current, power consumption
- 
**Extra I/O Ports for Sensor Expandability**
  - Environment Monitor
  - Traffic Monitor
  - Security Surveillance
  - Genetic Activities Monitor
- 
**Reliable Mesh Network**
  - Self proprietary wireless control nodes
  - Reliable node to node, gateway to node communication
  - Up to 1000 nodes per network
  - Max. network diameter 2000m
- 
**Easy-to-use Platform**
  - Easy monitor on each and all lights status
  - Support lighting policy remote setup

**OPTIONS:**

Dimmable Driver 1 -10 / DALI
Backup Emergency Kit 3Hr

**SPECIFICATIONS:**

Model	Wattage	Lumen	Light Source	Driver Type	L	W	H
EO-SST-30	30W	3900-4500 Lm	SMD5050 Chips	Constant Current LED Driver	513mm	180mm	85mm
EO-SST-50	50W	6500-7500 Lm	SMD5050 Chips	Constant Current LED Driver	513mm	180mm	85mm
EO-SST-60	60W	7800-9,000 Lm	SMD5050 Chips	Constant Current LED Driver	513mm	180mm	85mm
EO-SST-90	90W	11,700-13,500 Lm	SMD5050 Chips	Constant Current LED Driver	613mm	206mm	84mm



**RELIABILITY  
UNEXPECTED VALUE**

**Optics:**  
Optical systems for outdoor luminaires must be designed to satisfy several criteria in terms of luminaire performance. With a variety of light distributions, Star light engine features best in class optical performances. It is designed for convenience and economics, achieving wide column spacing, excellent uniformity plus no waste or obtrusive light.

**Ready To Connect:**  
Future proof luminaire with removable control gear and optic also compatible with any existing IoT options on the market thanks to the NEMA socket option. There are also 3/5/7 pins for you to choose from.

**Installation:**  
Star series street lights are easy to install without burying cables, rectifiers, and so on. They can be directly installed on the lamp pole. There is adjustable spigot 0°/90°.

**PHOTOMETRICS**

**Optimized Comfort**

In many urban road applications, comfort is a key standard. The optics of Star series light is designed to enhance comfort with reduced glare.

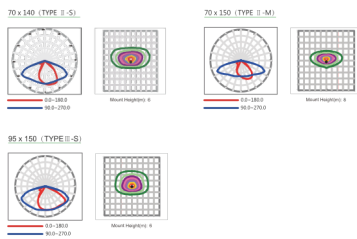

Much more than a budget-friendly outdoor luminaire with the latest generation of LED modules, Star is highly convenient yet. Available in different discrete sizes, it is designed to maximize lighting performance, and realize an economic and convenient dual road strategy. At the same time, it limits carbon emissions and achieves a green cycle.

Thanks to Star's high performance and substantial benefits, it is the perfect answer to the current and future project needs.

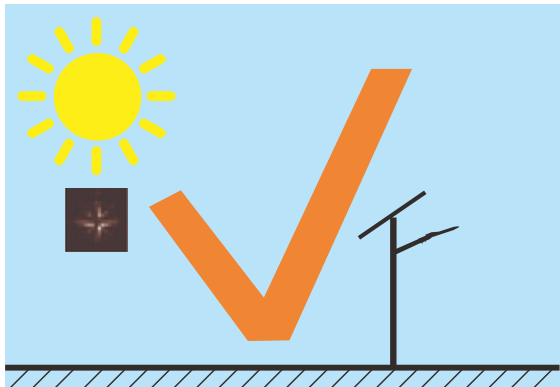
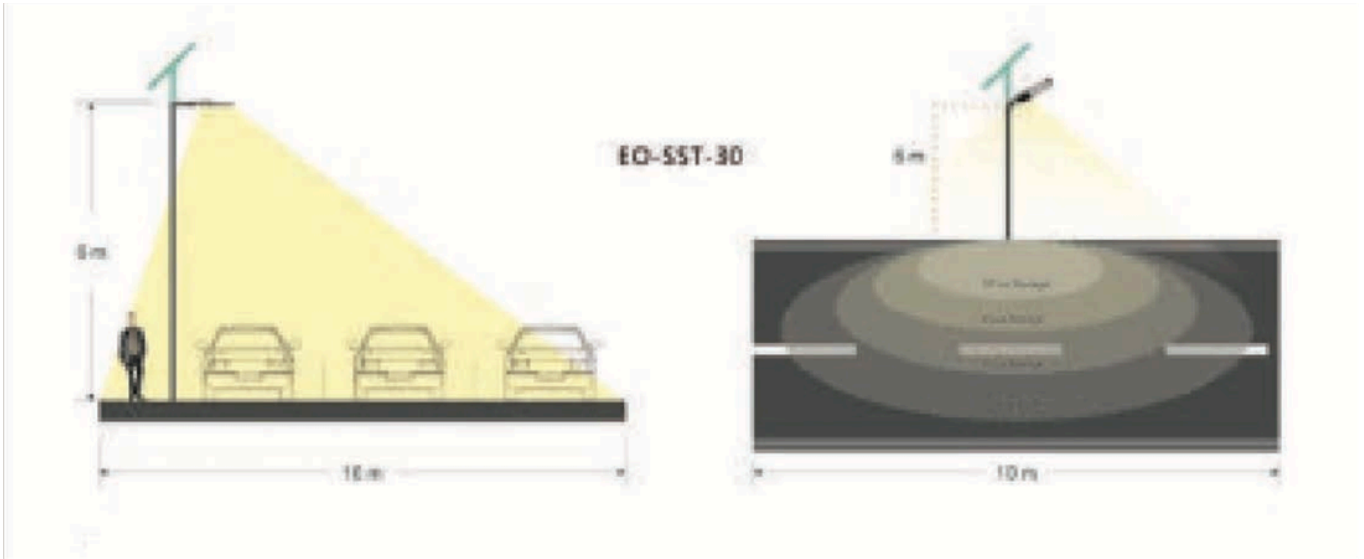

The solar panel can be adjusted to the best angle where it is able to absorb maximum sunshine. The most optimum direction to face the solar panel is somewhere between south and west. It is at this location that the panel will receive the maximum sunlight throughout the day.

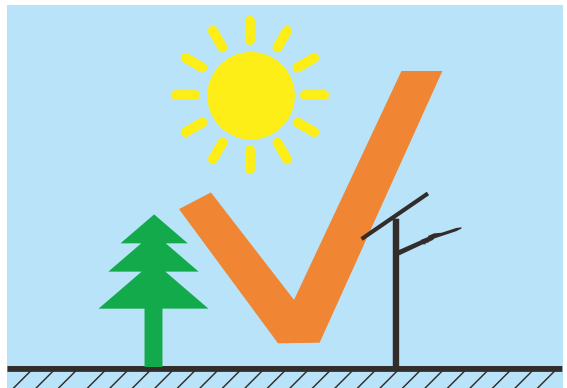
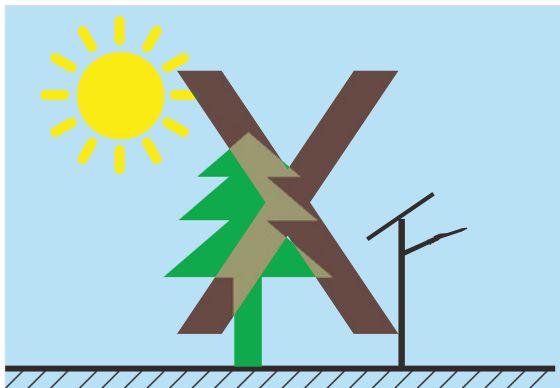











# STQ Series IP65

## APPLICATIONS:

Suitable to be used in : Street lighting, urban area lighting .

التطبيقات  
مناسبة للاستخدام في : إنارة الشوارع و المناطق الحضرية .





### General Specifications:

 Mounted	Pole Mounting
 Material	Die casted aluminium
 IP	IP65
 -	-
 -20 : 45°C	-20 : 45°C
 warranty	5 Years

### Optical Data:

 chips	High Quality LED Chip
 COB SMD	SMD
 Lm	190lm/W
 beam angle	99.7°/109.9°
 CCT	2500~6500K
 CRI	> 70

### Electrical Data:

 LED Wattage	10W/25W/45W/50W/75W/100W/140W
 driver	Constant current LED driver
 Voltage	(12-24) Vac
 HZ	50-60 Hz
 PF	-



### Introduction :

Solar powered outdoor lighting products are ideal for lighting the area in remote locations where the electricity is unavailable or erratic. Even in urban areas, these find great usage to reduce dependency on conventional power and contribute towards green energy. Reliable and long life makes this solution effective in fulfilling our present and future lighting requirements

### KEY FEATURES

- System Light Efficacy 190 LPW with high performance LED chips.
- Solar powered-No need for any other power supply or electrical cabling.
- Automatic dusk to dawn operation(or timer options).
- Highly efficient monocrystalline silicon photovoltaic panels.
- Easy to Install and Maintain.



Round poles



Round poles / Square poles / wall mount



SPECIFICATIONS:

Model	Wattage	Lumen	Beam Angle	Driver Type	L	W	H
STQ10W	10W	1500 Lm	140°x170°	Constant Current LED Driver	410mm	183mm	77mm
STQ25W	25W	3750 Lm	140°x170°	Constant Current LED Driver	520mm	238mm	113mm
STQ45W	45W	8100 Lm	140°x170°	Constant Current LED Driver	520mm	238mm	113mm
STQ50W	50W	9500 Lm	140°x170°	Constant Current LED Driver	800mm	312mm	123mm
STQ75W	75W	14,250 Lm	140°x170°	Constant Current LED Driver	800mm	312mm	123mm
STQ100W	100W	17,000 Lm	140°x170°	Constant Current LED Driver	800mm	312mm	123mm
STQ140W	140W	23,800 Lm	140°x170°	Constant Current LED Driver	800mm	312mm	123mm

SIZE | LED-STQ-10W

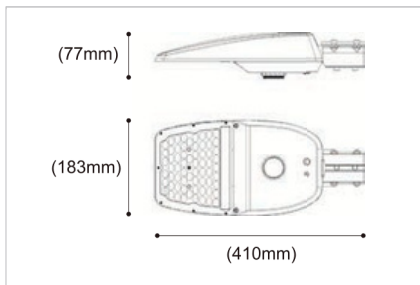

SIZE | LED-STQ-25W

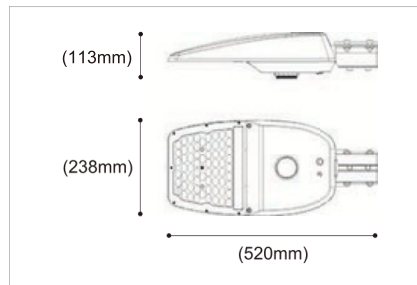

SIZE | LED-STQ-45W

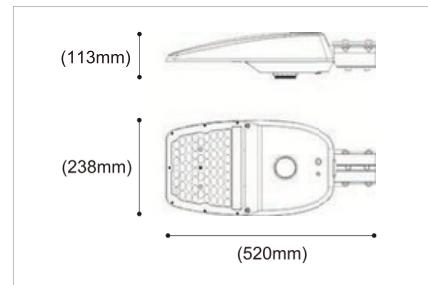

SIZE | LED-STQ-50W

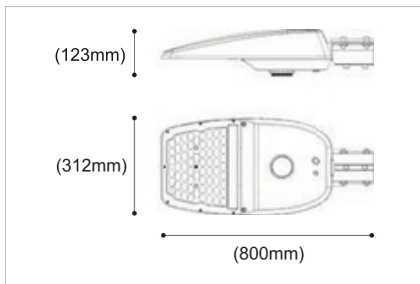

SIZE | LED-STQ-75W

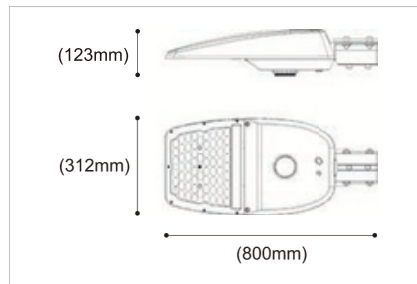

SIZE | LED-STQ-100W

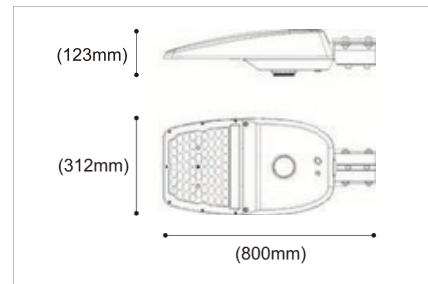

SIZE | LED-STQ-140W

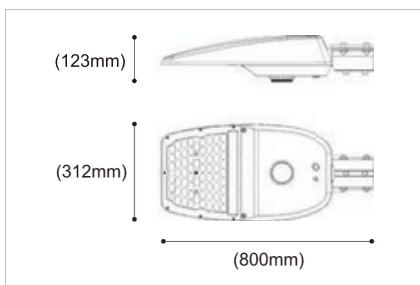

LIGHT DISTRIBUTION

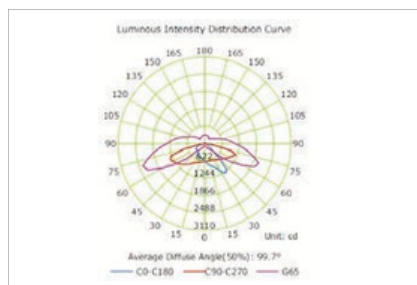

LIGHT DISTRIBUTION

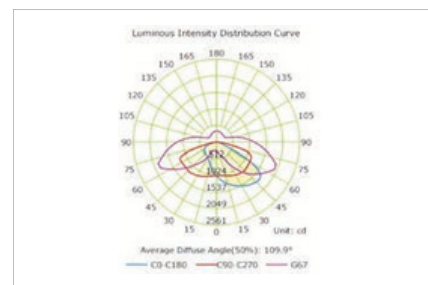

High light efficiency LED

use high efficiency LED, light effect 260Lm/W, The lens is a PC material with anti - UV, anti- aging and anti - impact properties



The new design improves lighting effects and uniformity; while also significantly improving Lux value on the ground



Dedicated Charging Port (use it with external charger )

ON/OFF Switch

### Built in MPPT controller

- Motion microwave sensor
- Timing function
- Period of time function
- Remote control function

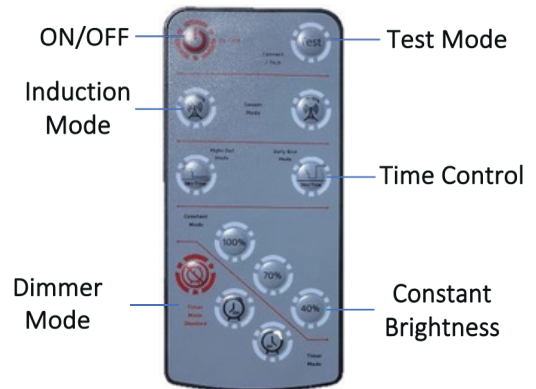

### LIGHT POLE ADAPTERS

Convenient, quick installation bracket and tenon accessories, solid and reliable , users only need to install and use the round pole , no need to consider other light pole accessories.



# NSB - 03 IP65

## APPLICATIONS:

Suitable to be used in : Street lighting, urban area lighting .

التطبيقات  
مناسبة للاستخدام في : إنارة الشوارع و المناطق الحضرية .





## General Specifications:

 Mounted	Pole Mounting
 Material	Die casted aluminium
 IP	IP65
	50,000 Hrs ( L70 @ 25C° )
	-20 : 55°C
 warranty	5 Years

## Optical Data:

 chips	High Quality LED Chip
 COB SMD	SMD
 Lm	170 or 200lm/W
 beam angle	Type II
 CCT	3000K-6500K
 CRI	> 70-80

## Electrical Data:

 LED Wattage	10W/15W/20W/25W/30W/35W 40W/45W/50W/60W
 driver	Constant current LED driver
 Voltage	(12-24) Vac
 HZ	50-60 Hz
 PF	-



## Introduction :

Solar powered outdoor lighting products are ideal for lighting the area in remote locations where the electricity is unavailable or erratic. Even in urban areas, these find great usage to reduce dependency on conventional power and contribute towards green energy. Reliable and long life makes this solution effective in fulfilling our present and future lighting requirements

## KEY FEATURES

- System Light Efficacy 170-200 LPW with high performance LED chips.
- Solar powered-No need for any other power supply or electrical cabling.
- Automatic dusk to dawn operation(or timer options).
- Highly efficient monocrystalline silicon photovoltaic panels.
- Easy to Install and Maintain.



SPECIFICATIONS:

Model	Wattage	Lumen	Light Source	Driver Type	L	W	H
NSB-031-30W	30W	5100-6000 Lm	SMD5050 Chips	Constant Current LED Driver	735mm	373mm	108mm
NSB-031-40W	40W	6800-8000 Lm	SMD5050 Chips	Constant Current LED Driver	880mm	373mm	108mm
NSB-031-50W	50W	8500-10,000 Lm	SMD5050 Chips	Constant Current LED Driver	988mm	373mm	108mm
NSB-031-60W	60W	10,200-12,000 Lm	SMD5050 Chips	Constant Current LED Driver	1352mm	373mm	108mm
NSB-031-80W	80W	13,600-16,000 Lm	SMD5050 Chips	Constant Current LED Driver	1382mm	373mm	108mm
NSB-031-100W	100W	17,000-20,000 Lm	SMD5050 Chips	Constant Current LED Driver	1382mm	373mm	108mm

LIGHT DISTRIBUTION

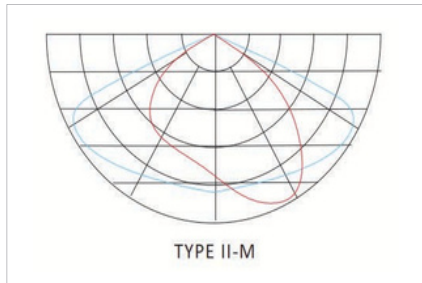

SIZE | LED-NSB-031-30W

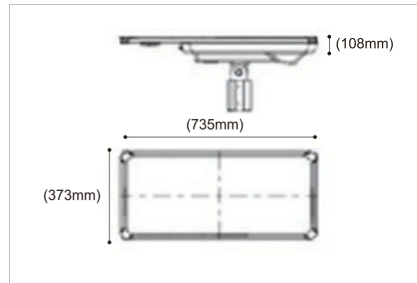

SIZE | LED-NSB-032-40W

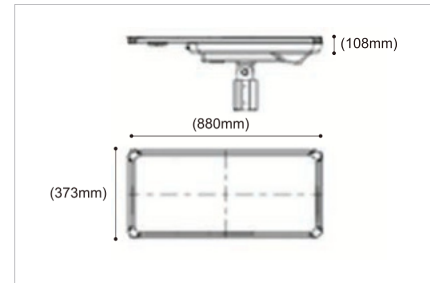

SIZE | LED-NSB-033-50W

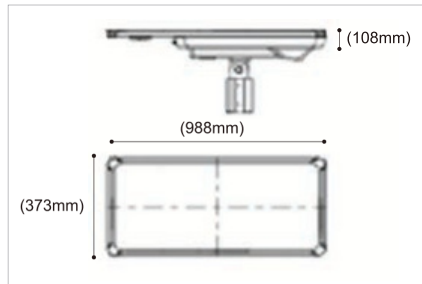

SIZE | LED-NSB-034-60W

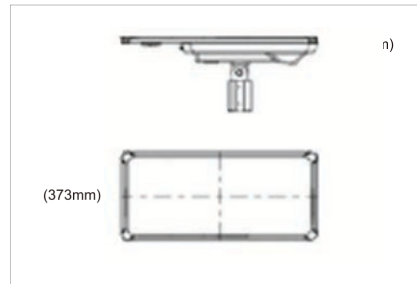

SIZE | LED-NSB-035-80W

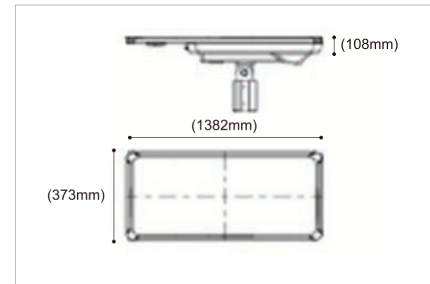

SIZE | LED-NSB-036-100W

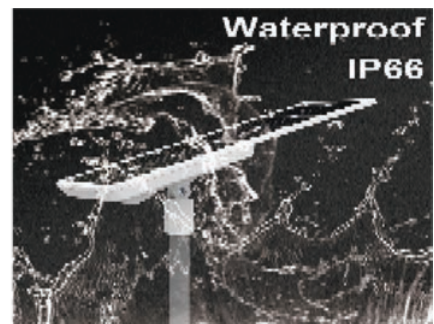
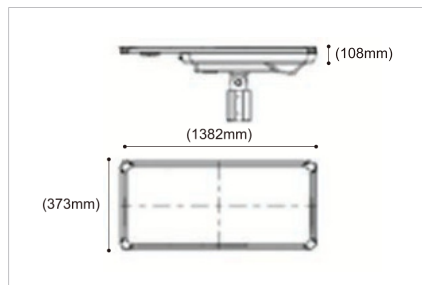





# LED - NSB - 06X IP67

## APPLICATIONS:

Suitable to be used in : Street lighting, urban area lighting .

التطبيقات  
مناسبة للاستخدام في : إنارة الشوارع و المناطق الحضرية .





### General Specifications:

 Mounted	Pole Mounting
 Material	Die casted aluminium
 IP	IP67
 52,000 Hrs ( L70 @ 25C° )	
 -10 : 30°C	
 10 Years	

### Optical Data:

 chips	High Quality LED Chip
 COB SMD	SMD
 Lm	180lm/W
 beam angle	108°/114°/116°
 CCT	2700K/6000K
 CRI	> 70-80-90

### Electrical Data:

 LED Wattage	100/120/150/180/200W
 driver	Constant current LED driver
 Voltage	(12-24) Vac
 HZ	50-60 Hz
 PF	-



## Introduction :

Solar powered outdoor lighting products are ideal for lighting the area in remote locations where the electricity is unavailable or erratic. Even in urban areas, these find great usage to reduce dependency on conventional power and contribute towards green energy. Reliable and long life makes this solution effective in fulfilling our present and future lighting requirements

## KEY FEATURES

- System Light Efficacy 170-200 LPW with high performance LED chips.
- Solar powered-No need for any other power supply or electrical cabling.
- Automatic dusk to dawn operation(or timer options).
- Highly efficient monocrystalline silicon photovoltaic panels.
- Easy to Install and Maintain.

## SPECIFICATIONS:

Model	Wattage	Lumen	Driver Type	L	W	H
NSB-061-100	100W	10,800 Lm	Constant Current LED Driver	1152mm	522mm	225mm
NSB-062-120	120W	14,400 Lm	Constant Current LED Driver	1532mm	522mm	225mm
NSB-063-150	150W	18,000 Lm	Constant Current LED Driver	1812mm	522mm	225mm
NSB-064-180	180W	18,000 Lm	Constant Current LED Driver	1812mm	522mm	522mm
NSB-065-200	200W	18,000 Lm	Constant Current LED Driver	1812mm	522mm	522mm



# KEY FEATURES



Premium-grade integrated all-in-one design, easy to install and maintain.



Environment friendly & electric bill free - 100% powered by the sun.



No trenching or cabling work needed.



Light on/off and dimming programmable smart lighting.



High luminous efficiency of 190~210lm/W to maximize battery performance.



Pivoting LED modules deliver the best lighting control.



IP66 Luminaire ensures long lasting and consistent high performance.



Five Years Warranty.

# LIGHTING APPLICA

- OFFICE
- SHOP
- INDUS
- TASK &
- HOSP
- OUTD

# G TIONS

E

STRY  
& EDUCATIONAL  
ITALS  
DOR APPLICATIONS

Light Beyond Design

## CONTACT US

-  RMAD7717 , Riyadh , KSA
-  +966 58 066 3987
-  [info@lumiereighting.com](mailto:info@lumiereighting.com)
-  [www.lumiereighting.com](http://www.lumiereighting.com)